



Service You Can Build On

A detailed pencil-style illustration of two hands shaking over a wooden plank. The hands are rendered with fine lines and shading, giving them a realistic, textured appearance. The wooden plank is positioned horizontally between the hands, and the entire scene is set against a yellow background.

*Carpenters'
Moulding
Guide*

AUSTIN

512•989•1445

GoWestPac.com



April • 2021



For over 30 years, the local ownership of Western Pacific has been supplying the building industry with quality products for new home construction.

As an environmentally and socially conscious company, we source the majority our windows, doors and mouldings from regionally owned and operated manufacturers in the Pacific Northwest.

Our mission is to supply quality products on time to meet evolving homebuilders' requirements. We appreciate your business and look forward to working together on your home.

ROUGH OPENINGS



LEFT HAND SWING

INTERIOR SINGLE DOORS

DOOR SIZE	OPENING SIZE
2'-0"	26"X82"
2'-4"	30"X82"
2'-6"	32"X82"
2'-8"	34"X82"
3'-0"	38"X82"



RIGHT HAND SWING

INTERIOR

ASTRAGAL PAIRS

DOOR SIZE	OPENING SIZE
2'-0"	50-1/2"X82"
2'-4"	58-1/2"X82"
2'-6"	62-1/2"X82"
2'-8"	66-1/2"X82"
3'-0"	74-1/2"X82"

BALL CATCH PAIRS

DOOR SIZE	OPENING SIZE
2'-0"	50"X82"
2'-4"	58"X82"
2'-6"	62"X82"
2'-8"	66"X82"
3'-0"	74"X82"

INTERIOR

BIFOLDS

DRYWALL JAMB:
(DOOR WIDTH + 1-1/4")

WOOD FULL JAMB:
(DOOR WIDTH + 2")

BIPASS DOOR

DRYWALL JAMB:
(DOOR WIDTH X 2)

WOOD FULL JAMB
(DOOR WIDTH X 2) + 1"

POCKET DOOR

WOOD FRAME
(DOOR WIDTH X 2) + 2"
(DOOR HEIGHT) + 4-1/2"
EXAMPLE: 2668 = 62" X 84"

JOHNSON FRAME
(DOOR WIDTH X 2) + 1"
(DOOR HEIGHT) + 4-1/2"
EXAMPLE: 2668 = 61" X 84-1/2"

EXTERIOR

EXTERIOR SINGLE DOORS

	6/8	7/0	8/0
2' 6"	32" X 83"	32" X 87"	32" X 99"
2' 8"	34" X 83"	34" X 87"	34" X 99"
2' 10"	36" X 83"	36" X 87"	36" X 99"
3' 0"	38" X 83"	38" X 87"	38" X 99"

12" TRANSOMS OVER 6'8" DOORS
ARE NORMALLY 94-1/2" HEIGHT

EXTERIOR SIDELITE UNIT

ONE SIDELITE, ONE DOOR
(DOOR WIDTH) + (S/L WIDTH) + 3-1/2"

TWO SIDELITES, ONE DOOR
(DOOR WIDTH) + (S/L WIDTH X 2) + 5"

TWO SIDELITES, TWO DOORS
(DOOR WIDTH X 2) + (S/L WIDTH X 2) + 6"

6' 8" HEIGHT: 83"

7' 0" HEIGHT: 87"

8' 0" HEIGHT: 99"

EXTERIOR PAIRS

(DOOR WIDTH X 2) + 3"

6' 8" HEIGHT: 83"

7' 0" HEIGHT: 87"

8' 0" HEIGHT: 99"

SERVICES



JOB SITE TAKEOFF

Our experienced, professional team will walk your jobsite and do a detailed takeoff, including as needed: prehung doors, millwork, stairparts, locks & hardware, and windows.



PREHUNG DOORS

Your dedicated WestPac team will machine and assemble our quality doors together with jambs, brickmould, weatherseals, and other components into a ready-to-install unit, with great care and quality in mind.



CUSTOM DOORS

If you're aiming for unique interior design, or exclusive entry doors, we have experts on hand who will transform your creative vision into reality.



CUSTOM MILLWORK

Whether it's beautiful arch surrounds and casing, custom run moulding patterns, or exotic wood species, we have you covered with WestPac's experienced custom millwork shop.



HAND PULLED MOULDING PACKS

We take pride in our vast assortment of casing, base, crown, and closet material, and we'll handle with care as we package your items in the quantities and lengths you need.



JOB SITE DELIVERY

We deliver, rain or shine, on time to your jobsite. We get your order right and deliver it to your site quickly, so you can meet your deadlines with no surprises.



MOBILE APP

Maximize your efficiency by getting up-to-the-minute updates on your order status and delivery schedule by using our WestPac mobile app.

BASIC MOULDING TERMINOLOGY

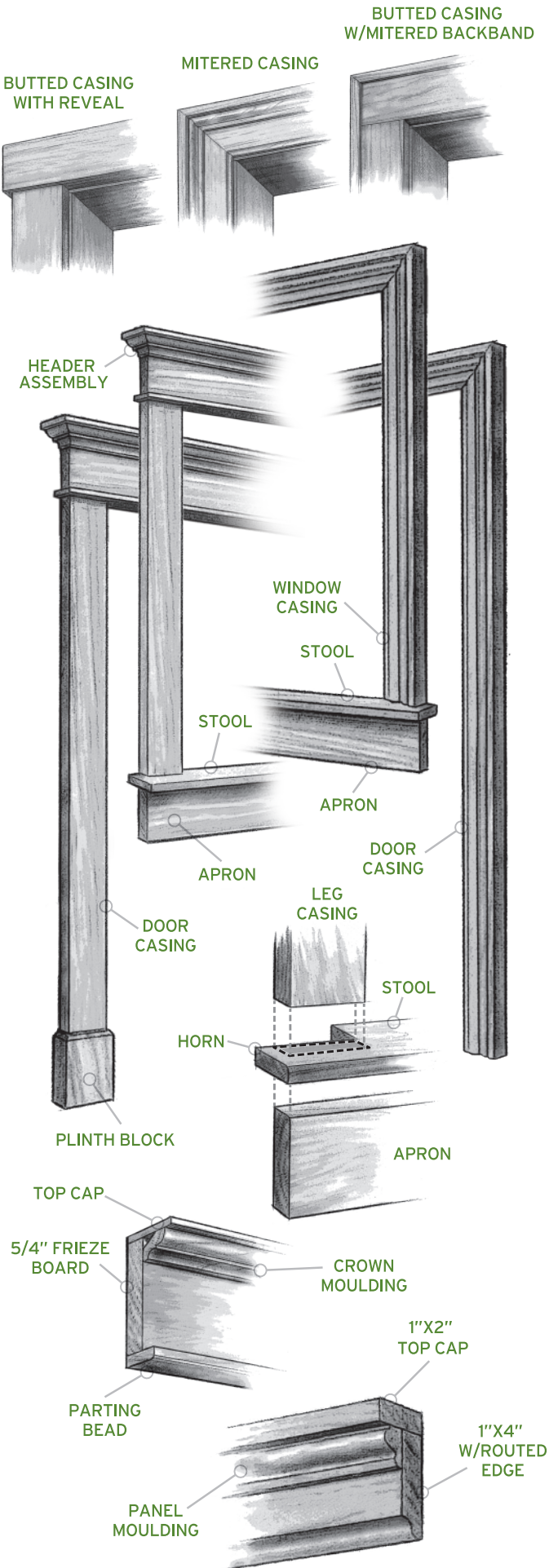

BASIC MOULDING TERMINOLOGY

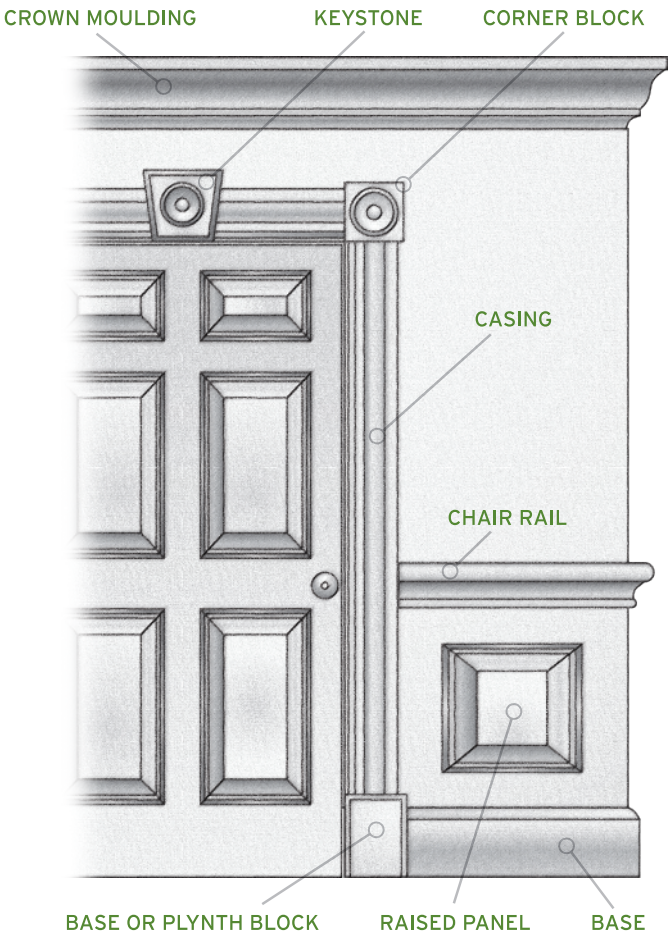
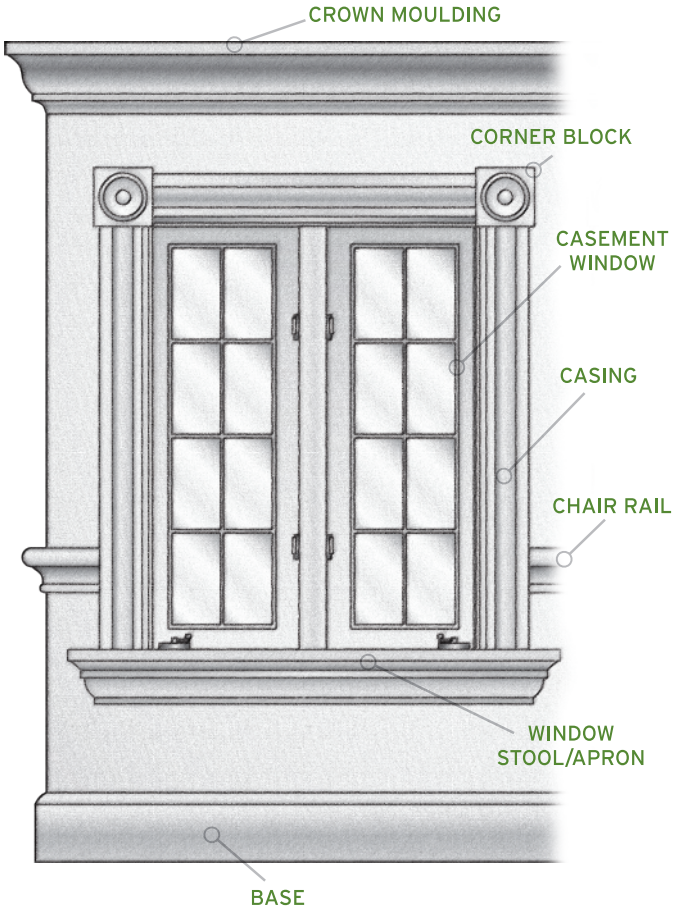

TRADITIONAL Style

A

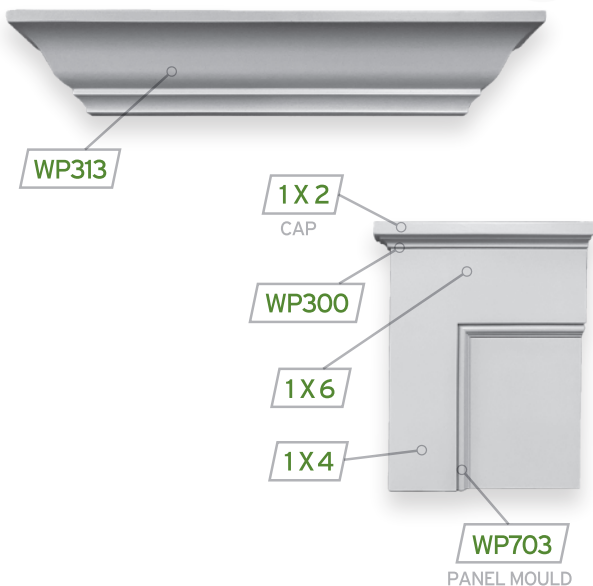

CRAFTSMAN Style

B

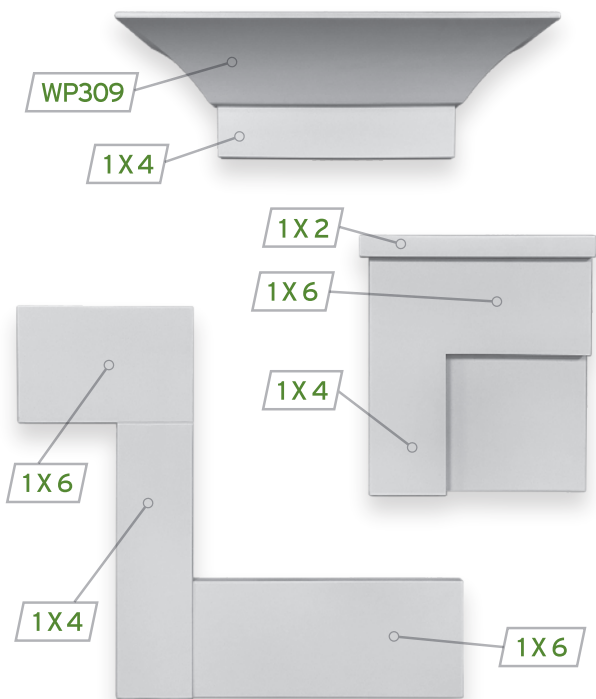

MOULDING

FLAT STOCK

INTERIOR DOORS

STAIR PARTS

TECHNICAL INFORMATION

NOTES

CRAFTSMAN

Style

C

MOULDING

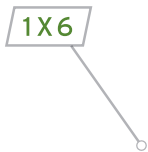
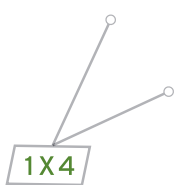
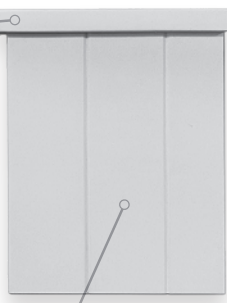

FLAT STOCK

INTERIOR DOORS

STAIR PARTS

TECHNICAL INFORMATION

NOTES

CLASSIC

Style

D

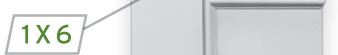

TRADITIONAL Style

E

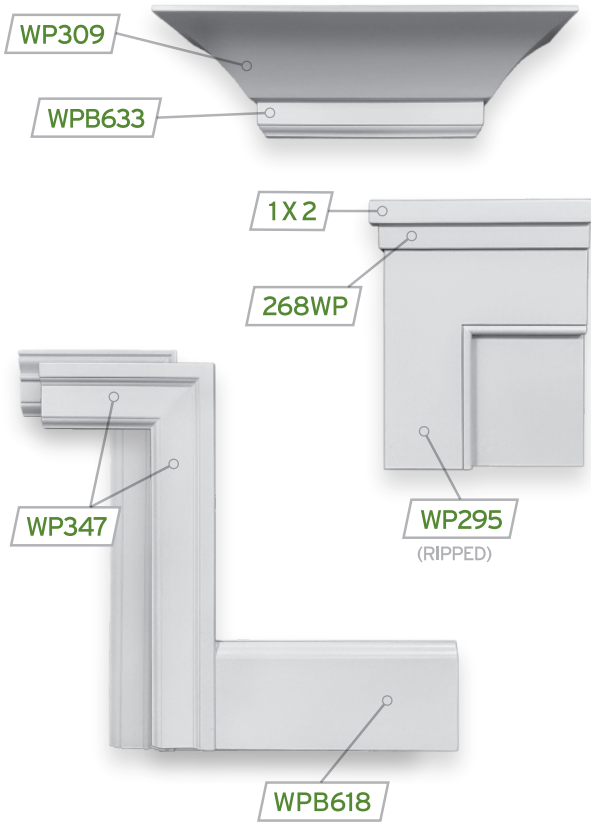

MOULDING

FLAT STOCK

INTERIOR DOORS

STAIR PARTS

TRADITIONAL Style

F

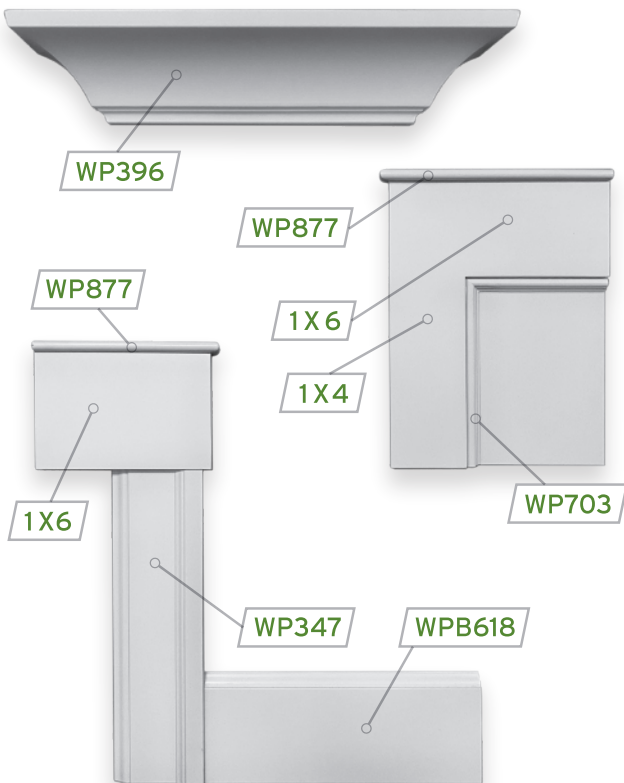

TECHNICAL INFORMATION

NOTES

TRADITIONAL

Style

G

MOULDING

FLAT STOCK

INTERIOR DOORS

STAIR PARTS

TECHNICAL INFORMATION

NOTES

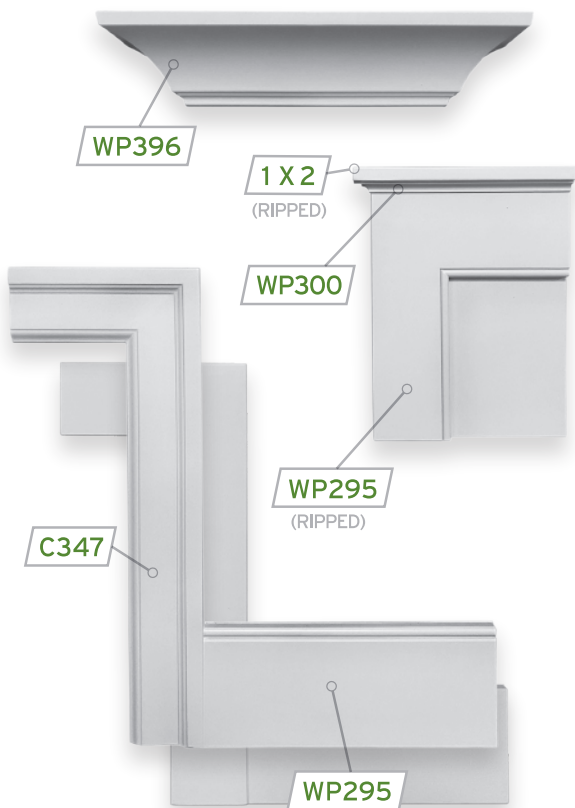

CRAFTSMAN

Style

H

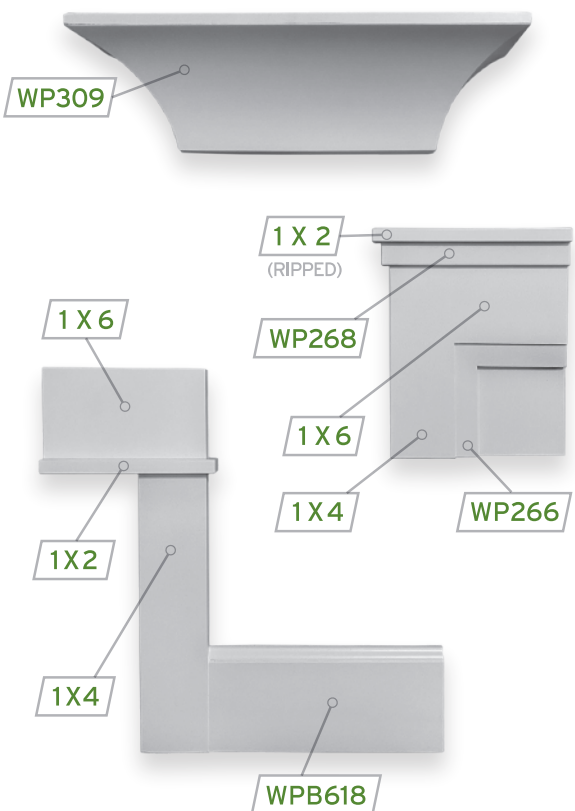



WP216

S4S
BASE
19/32" X 5-1/2"



WP225

BASE
19/32" X 5-1/2"



WP125

CASING
13/16" X 3-1/2"

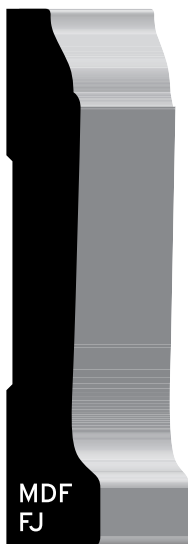
**WPC346**CASING
5/8" X 2-1/4"**WPC347**CASING
9/16" X 3-1/2"**WPB618**BASE
9/16" X 5-1/4"**WPB633**BASE
1/2" X 3-1/4"



WP111
CASING
1-1/8" X 3-1/2"



WP112
CASING
11/16" X 3-1/2"



WP211*
BASE
1-1/16" X 4-1/2"



WP121
CASING
5/8" X 2-1/2"



WP213
BASE
9/16" X 5-1/8"



WP212
BASE
9/16" X 4-1/2"



WPC295

BASE
11/16" X 3-1/2"



WPB695

BASE
9/16" X 6-1/2"



WPB395

BASE
9/16" X 4-1/2"

Moulding dimensions subject to change without notice, contact your local WestPac office for correct dimensions

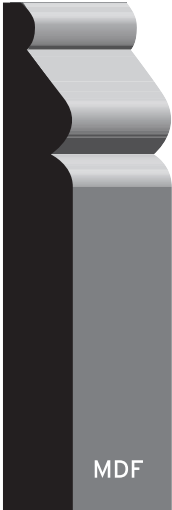

WPB2184

BASE
9/16" X 4"



WPB218514

BASE
9/16" X 5-1/4"



WP432

BASE
9/16" X 3-1/4"



WP295

BASE
9/16" X 5-1/4"



WP297

BASE
9/16" X 7"

Moulding dimensions subject to change without notice, contact your local WestPac office for correct dimensions



WP209

BASE
1/2" X 5-1/4"



WP208

BASE
9/16" X 3-1/4"



WPB514

BASE
1/2" X 5-3/16"



WPB314

BASE
1/2" X 3-3/16"

Moulding dimensions subject to change without notice, contact your local WestPac office for correct dimensions



PFJ

C322

CASING
5/8" X 2-1/2"



PFJ

C522

CASING
5/8" X 3-1/2"



FJ

B322

CASING
9/16" X 3-1/2"



FJ

B522

CASING
9/16" X 3-1/2"

Moulding dimensions subject to change without notice, contact your local WestPac office for correct dimensions



WP108

CASING
9/16" X 2-1/2"



C218

CASING
5/8" X 2-1/8"



WP113

CASING
9/16" X 3-1/2"

Moulding dimensions subject to change without notice, contact your local WestPac office for correct dimensions



WP110*
CASING
9/16" X 3-3/8"



WPFP*
FLUTED PILASTER
11/16" X 5-1/2"



BASEBLOCK*
1-1/8" X 6-1/2"

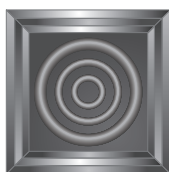

BULLSEYE ROSETTE
3-1/2" X 3-1/2"
5-1/2" X 5-1/2"

Moulding dimensions subject to change without notice, contact your local WestPac office for correct dimensions



WP355

CROWN
9/16" X 5-1/2"

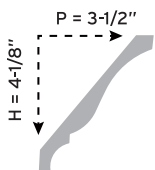

WP313

CROWN
9/16" X 4-1/4"

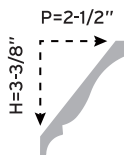

WP312

CROWN
9/16" X 3-5/8"

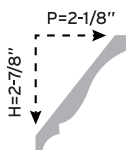

WP352

CROWN
9/16" X 2-3/4"

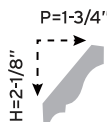

Moulding dimensions subject to change without notice, contact your local WestPac office for correct dimensions



WP322

CROWN
9/16" X 4-1/2"

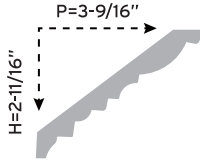

WP373*

PICTURE MOULD
11/16" X 1-3/4"



WP374*

BED MOULD
9/16" X 1-3/4"

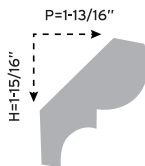

Moulding dimensions subject to change without notice, contact your local WestPac office for correct dimensions

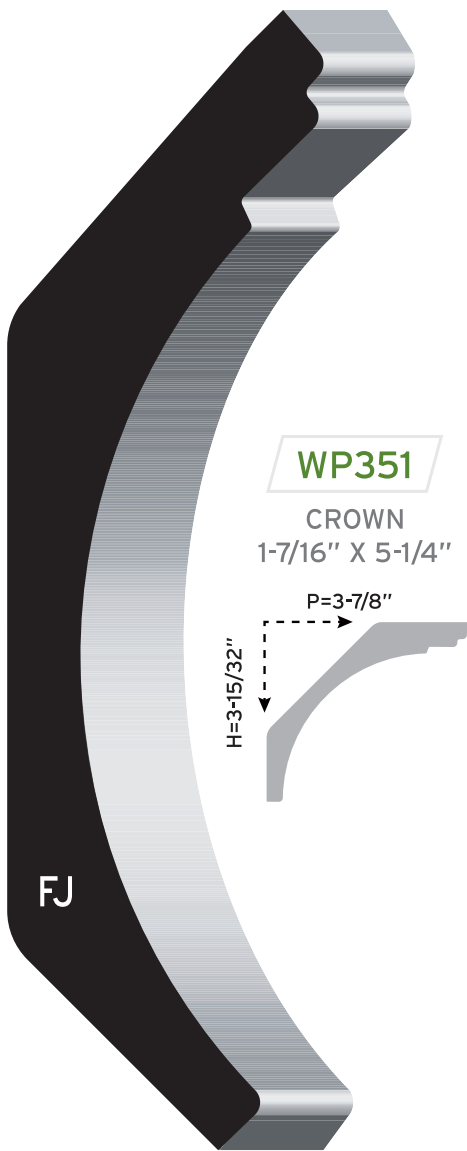

WP351

CROWN
1-7/16" X 5-1/4"

P=3-7/8"

H=3-15/32"



WP351C*

CRADLE
1-7/16" X 2-1/2"

Moulding dimensions subject to change without notice, contact your local WestPac office for correct dimensions

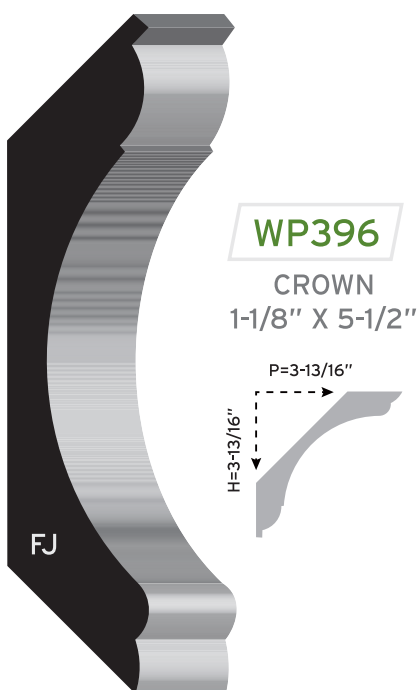
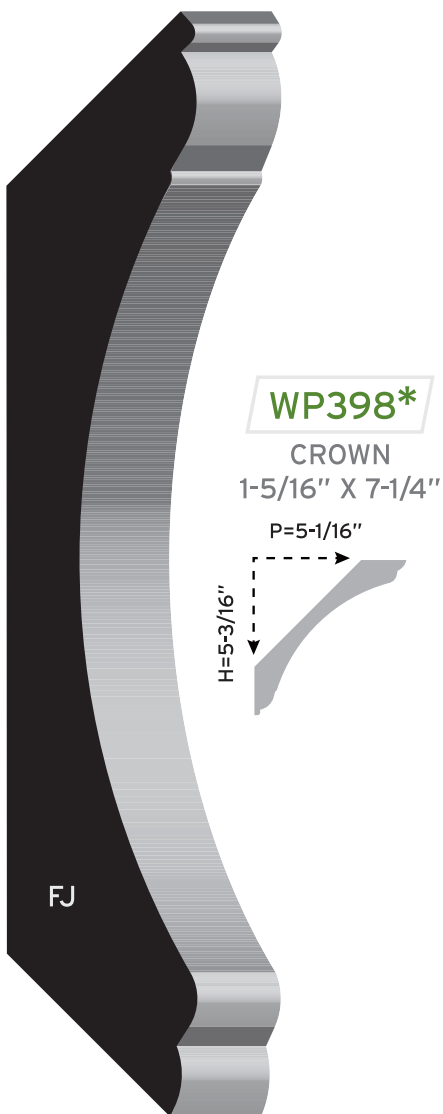

Moulding dimensions subject to change without notice, contact your local WestPac office for correct dimensions

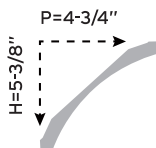

PFJ

WP310CROWN
1" X 7"

H=5-3/8"

P=4-3/4"

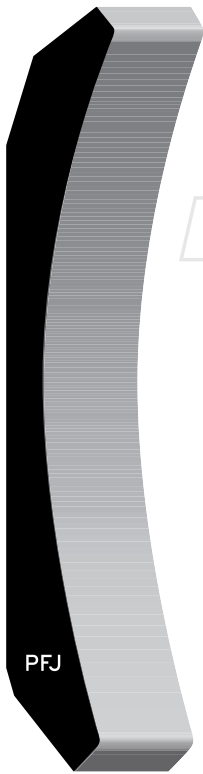

PFJ

WP309CROWN
11/16" X 5-1/4"

H=4-1/4"

P=3-3/8"

Moulding dimensions subject to change without notice, contact your local WestPac office for correct dimensions

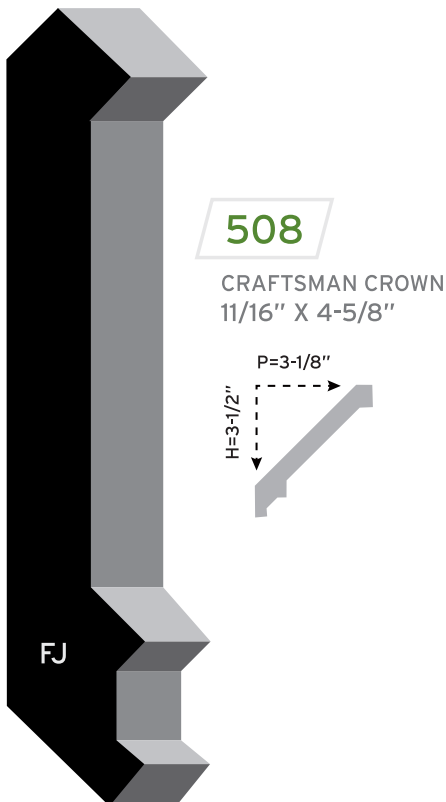
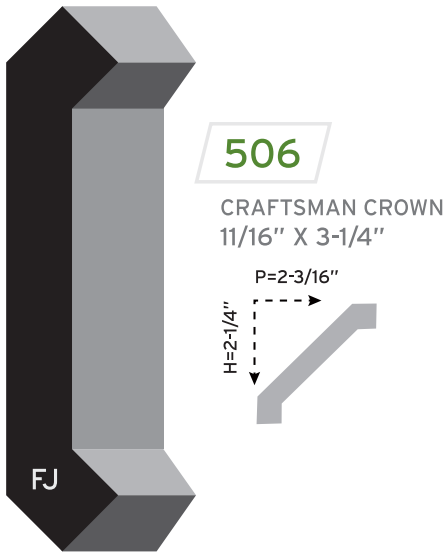

Moulding dimensions subject to change without notice, contact your local WestPac office for correct dimensions



WP300

COVE
11/16" X 11/16"
WP



WP705

PANEL MOULD
3/4" X 1-1/8"
WP



WP701*

PANEL MOULD
3/4" X 1-1/4"



WP788*

DOOR MOULD
11/16" X 1-1/2"
WP



WP706

PANEL MOULD
3/4" X 2"
WP



WP711*

DOOR MOULD
5/16" X 3/4"
WP



WP703

DOOR MOULD
7/16" X 11/16"

Moulding dimensions subject to change without notice, contact your local WestPac office for correct dimensions



WP

WP902

BACKBAND
11/16" X 1-1/8"



BYP*

BEADED CEILING
5/8" X 3-1/2"



122YP*

1" X 6"
T&G



1X8

NICKEL GAP

*SPECIAL ORDER

PROFILES ARE NOT NECESSARILY ACTUAL SIZE

Moulding dimensions subject to change without notice, contact your local WestPac office for correct dimensions



WP404

OUTSIDE CORNER
1-1/8" X 1-1/8"
WP



WP403

OUTSIDE CORNER
3/4" X 3/4"
WP



WP451

SHOE MOULD
7/16" X 3/4"
FX • PFJ • WP



WP324

QUARTER ROUND
3/4" X 3/4"

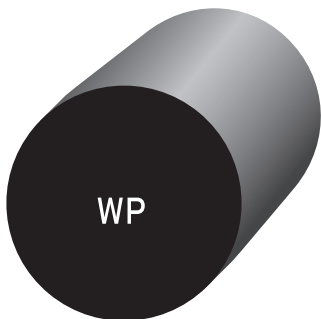

WP433

FULL ROUND
1-3/16" X 1-3/16"

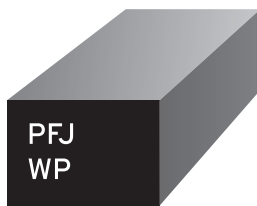

PFJ
WP

WP254

1/2" X 3/4"



WP316

HALF ROUND
11/16" X 1-1/2"



WP342

SCREEN MOULD
1/4" X 3/4"

Moulding dimensions subject to change without notice, contact your local WestPac office for correct dimensions



FJ

WP1006*

CHAIR RAIL
1-1/4" X 3-1/2"



FJ

WP1001*

MANTEL MOULD
1-1/2" X 4-5/8"



FJ

WP1007

CHAIR RAIL
1-1/8" X 2-1/2"

MOULDING

FLAT STOCK

INTERIOR DOORS

STAIR PARTS

TECHNICAL INFORMATION

NOTES

Moulding dimensions subject to change without notice, contact your local WestPac office for correct dimensions



FJ
WP

WP9248

11/16" X 1-3/4"



FJ
WP

WP876

7/16" X 1-3/8"



WP

WB268

1/4" X 1-1/8"



FJ
WP
MH
PVC

WP180

BRICK MOULD
1-1/4" X 2"



FJ
MDF

WP514

WINDOW STOOL
1/4" X 5-1/4"



FJ
MDF

WP614*

WINDOW STOOL
11/16" X 6-1/4"



FJ
MDF

WP714

WINDOW STOOL
11/16" X 7-1/4"

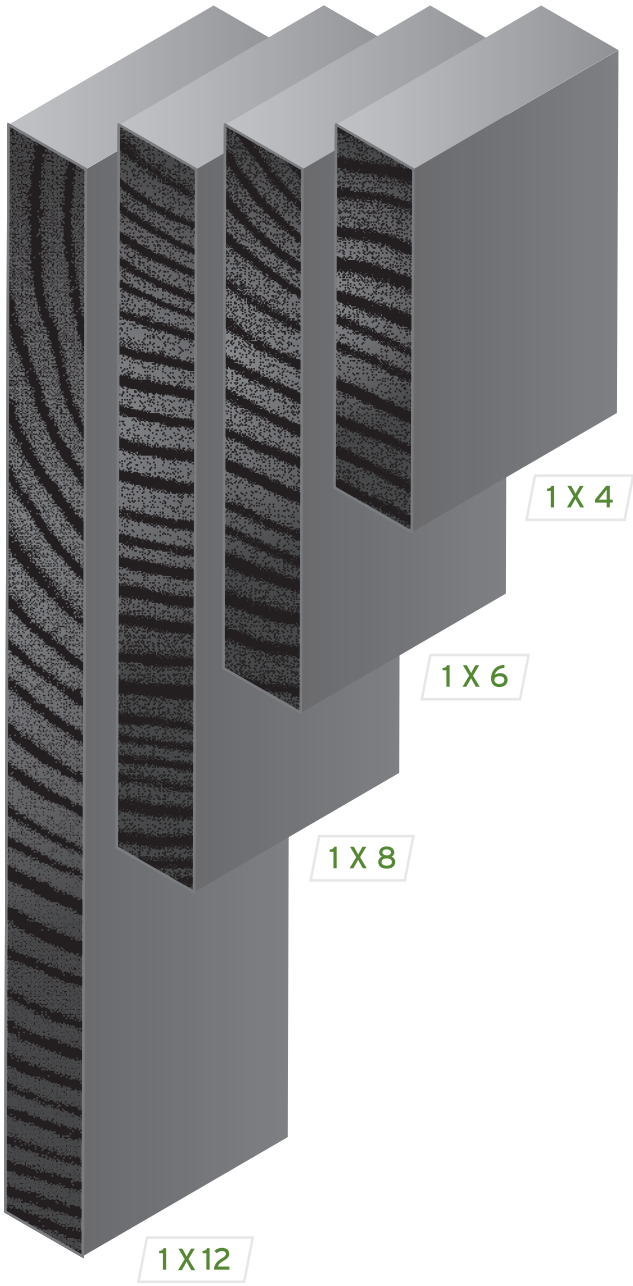

STOCKED IN:
 PRIMED FINGER JOINT
 MDF
 WHITE PINE
 POPLAR
 RED OAK

- MOULDING
- FLAT STOCK**
- INTERIOR DOORS
- STAIR PARTS
- TECHNICAL INFORMATION
- NOTES



SC HDBD

HARDBOARD
FLUSH
6/8 • 8/0

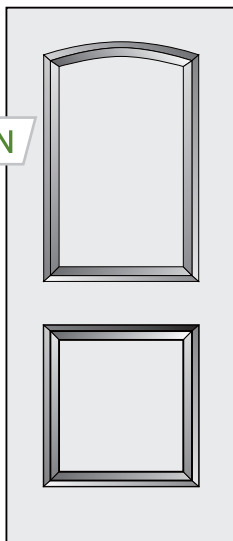

ROMAN

SMOOTH
PASSAGE/BIFOLD
6/8 • 8/0

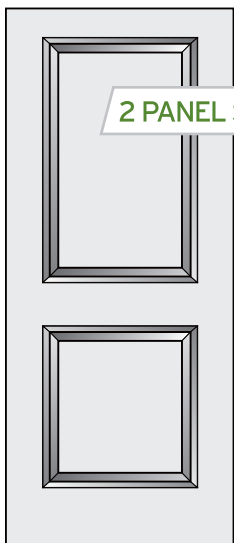

2 PANEL SQUARE

SMOOTH
PASSAGE/BIFOLD
6/8 • 8/0



CHEYENNE

SMOOTH
PASSAGE/BIFOLD
6/8 • 8/0

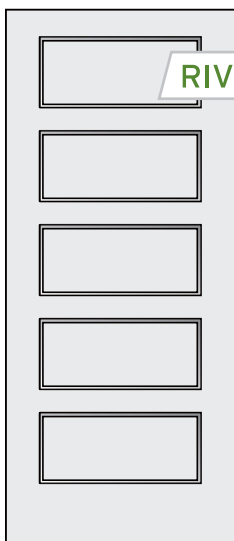

RIVERSIDE

RAISED PANEL
SMOOTH
PASSAGE/BIFOLD
6/8 • 8/0

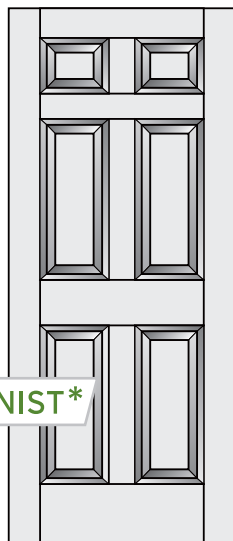

COLONIST*

SMOOTH
TEXTURED
PASSAGE/BIFOLD
6/8 • 8/0

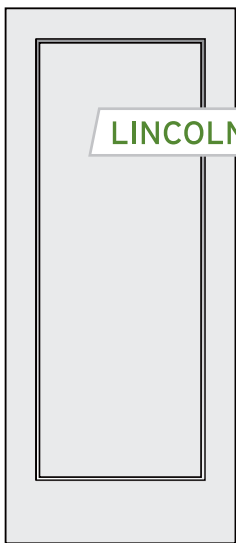

LINCOLN PARK*

FLAT PANEL
SMOOTH
PASSAGE/BIFOLD
6/8 • 8/0



WINSLOW*

FLAT PANEL
SMOOTH
PASSAGE/BIFOLD
6/8 ONLY

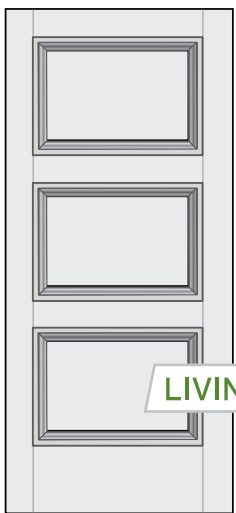

LIVINGSTON *

3 PANEL
SMOOTH
PASSAGE/BIFOLD
6/8 • 8/0

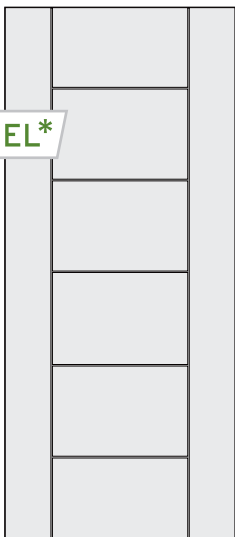

HAMEL*

SMOOTH
PASSAGE/BIFOLD
FLUSH W/KERF LINES
6/8 • 7/0

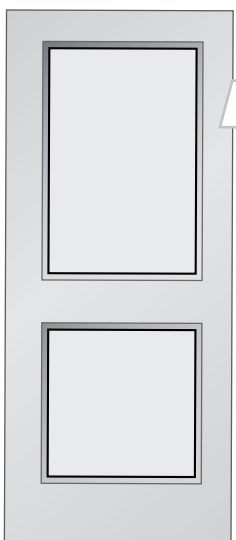

LOGAN*

FLAT PANEL
SMOOTH
PASSAGE/BIFOLD
6/8 • 8/0

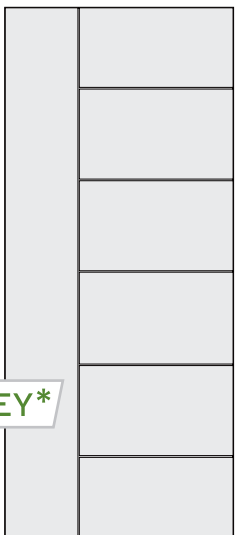

BERKLEY*

SMOOTH
PASSAGE/BIFOLD
FLUSH W/KERF LINES
6/8 • 7/0

SHAKER/SQUARE STICKING • FLAT PANEL

1-3/8" • STILE & RAIL • 6/8 & 8/0
(1-3/4" AVAILABLE IN 2/8 AND 3/0 WIDTHS)

MOULDING

FLAT STOCK

INTERIOR DOORS

STAIR PARTS

TECHNICAL INFORMATION

NOTES

730*

PRIMED
MDF

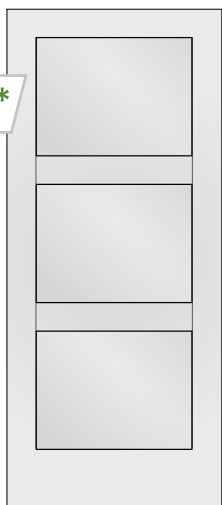

720*

PRIMED
MDF

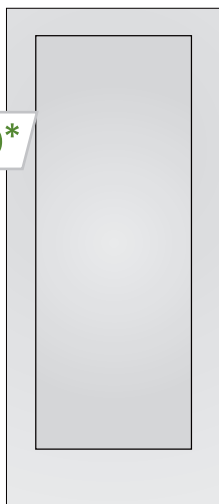

755*

PRIMED
MDF

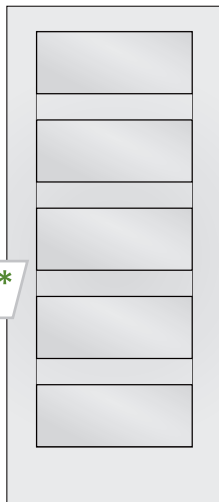

782*

PRIMED
MDF

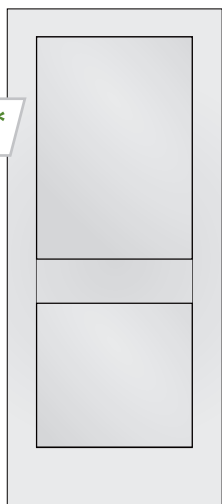

760*

PRIMED
MDF

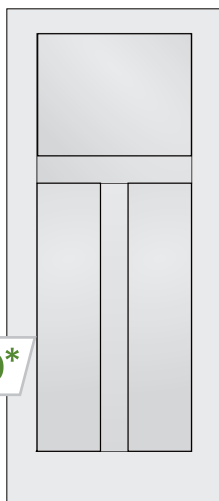

OAK NEWELS & TREADS

ALL RED OAK

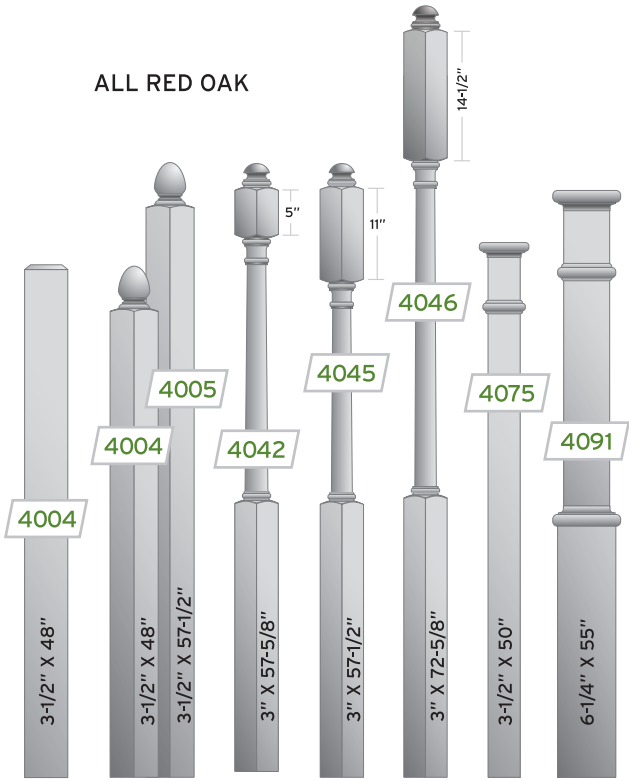

MOULDING

FLAT STOCK

INTERIOR DOORS

STAIR PARTS

TECHNICAL INFORMATION

NOTES

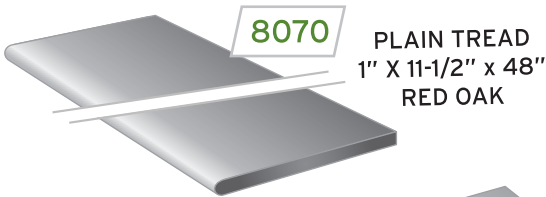

8070

PLAIN TREAD
1" X 11-1/2" x 48"
RED OAK

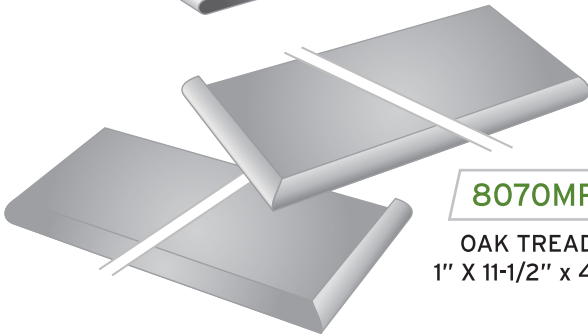

8070MR

OAK TREAD
1" X 11-1/2" x 48"

8071*
(SPECIFY LH or RH)
FALSE END CAP

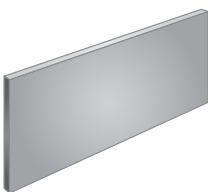
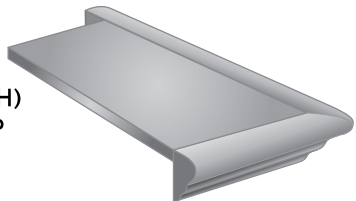

8076*
FALSE RISER

8072*
FALSE END CAP

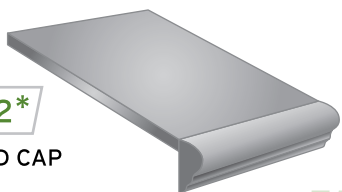

*SPECIAL ORDER

HANDRAILS & BALUSTERS

MOULDING

6040



6210



6010

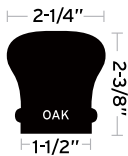

6002



Handrails can be plowed upon request

FLAT STOCK

INTERIOR DOORS

STAIR PARTS

TECHNICAL INFORMATION

NOTES



SATIN BLACK 1/2" HOLLOW IRON BALUSTERS

PSH02A
PITCH SHOE



AK01A
ADJUSTABLE
KNUCKLE



M06A
FLAT SHOE



STAIR HARDWARE

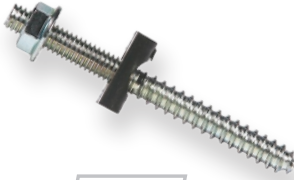

3001
RAIL BOLT



3000
1" OAK PLUG



3002
STANDARD DUTY
HANDRAIL BRACKET
CHROME
BLACK
SATIN NICKEL
DARK BRONZE



S3008
SURE-TITE
NEWEL FASTENER



7033
ROSETTE
4-5/16" X 6"
Red Oak



7037
OVAL ROSETTE
4" X 5-1/2"
Red Oak

MOULDING

FLAT STOCK

INTERIOR DOORS

STAIR PARTS

TECHNICAL INFORMATION

NOTES

STAINING INSTRUCTIONS

RECOMMENDED WOOD STAINING PROCEDURE

WOOD PREPARATION

Wood must be dry and cleaned of dirt, grease, wax, polish, and marks. See STEP 1 for details.

(For exterior wood doors, Western Pacific recommends Epifanes Wood Finish Matte top coat for the best results and long lasting finish. (Available at Marine Supply. Epifanes.com))

THE "FINGERNAIL TEST"

Determine if you have a soft wood or a hard wood.

We consider Fir, Hemlock and Alder to be softwoods and Oak, Cherry and Maple are typically hardwoods. If your fingernail dents the surface when you scratch it, you have a soft wood.

Since soft woods tend to absorb stain unevenly and become blotchy easily, pre-treat the wood using pre-stain wood conditioner before staining. This critical extra step will help you control stain color penetration and prevent blotchiness.

CHOOSING A COLOR

Your finished color is determined by many factors, from the color of the stain selected to how long the stain is left on.

But remember: Different species of wood absorb stain differently. Test the color on an inconspicuous area or sample board before you start staining the most visible parts of your project.

Always stop your staining process if you are not achieving your desired finish and ask a painting professional for additional advice.

To assure the highest quality results when applying interior wood stain, follow these steps:

STEP 1: Start with a medium grade of sandpaper (e.g., 120-grit) and gradually work your way to a finer grade (e.g., 220-grit).

Sand in the direction of the grain for a smooth uniform finish, and remove all sanding dust (using a vacuum, dry paint brush or tack cloth) before finishing.

STEP 2: Mix the stain thoroughly before you begin and frequently while you're staining. This helps keep the color consistent throughout the project. Ingredients in stains and finishes can settle over time. Stir until all settlement is evenly dispersed. Shaking will only add unwanted bubbles to the product.

STEP 3: Before proceeding, apply the stain on a discreet area of wood to test the color.

TIP: ●●●

Apply stain only at the proper temperature. For most stains, 70°F is the optimum, with the safety range from 50° to 90°F.

Stains do vary, so check the label first. Avoid high humidity when applying stain. All finishes, including stains and paint, have trouble drying in moist conditions.

STEP 4: Apply stain by brushing or wiping it in the direction of the grain, using smooth, even strokes. Wipe off any excess.

TIP: ●●●

Avoid unattractive lap marks by applying stain from an unpainted area back into the last wet stain. In other words, don't let a section of stain dry before you blend it in with stain from an adjoining section.

STEP 5: Let dry completely (usually 24 hours).

Apply a second coat of stain if you want a darker look.

STEP 6: After the wood is dry, brush or spray on a uniform coat of your top coat product. After the top coat dries, lightly sand the trim using 220-grit sandpaper to eliminate brush strokes or paint drips. Use a damp sponge or tack cloth to remove all sanding dust. Recoat your top coat and follow the sanding procedure until your desired finish is achieved.

MOULDING

FLAT STOCK

INTERIOR DOORS

STAIR PARTS

TECHNICAL INFORMATION

NOTES

FINISH LUMBER DESCRIPTIONS

3/4" thick with four square edges, and available in random lengths.

Custom Milling Available in all species:

- Sanding
- Ripping to Custom Width
- Planing to Custom Thickness

RED OAK

Sapwood is white to light brown and the heartwood is a pink or reddish brown. Similar in appearance to White Oak, but with smaller grain rays. Red Oak is mostly straight-grained, with a coarse texture.

WHITE OAK

The sapwood is light-colored and the heartwood is light to dark brown. White Oak is mostly straight-grained with a medium to coarse texture, and with longer grain rays than red oak.

EASTERN HARD MAPLE

Creamy white in color with a fine, uniform texture and generally mixed grain.

AMERICAN CHERRY

Rich red to reddish brown. Will darken with age and on exposure to light. May contain some creamy white sapwood. Fine uniform, straight grain, satiny, smooth texture.

CLEAR ALDER

Light brown with a yellow or reddish tinge. Fairly straight-grained with a uniform texture. Occasional pin knots may be present.

KNOTTY ALDER

Light brown with a yellow or reddish tinge. Fairly straight-grained with a uniform texture. Multiple large open and tight knots will be present.

PRIMED FJ PINE

Factory primed for superior paint finish applications.

EASTERN POPLAR

Solid paint grade hardwood. Smooth and even surface that paints out beautifully. Our high quality Eastern Poplar is lighter in color, more dense, and less fuzzy when machining than Western varieties.

CLEAR RADIATA PINE

Radiata Pine is plantation grown, has wide growth rings and is mostly knot free. Its neutral yellowish color is great for staining.

MOULDING

FLAT STOCK

INTERIOR DOORS

STAIR PARTS

TECHNICAL INFORMATION

NOTES

PAINTING INSTRUCTIONS

RECOMMENDED PROCEDURE TO PAINT WOOD AND MDF MOULDINGS AND BOARDS

MOULDING

PART 1 • PREPARE THE TRIM

STEP 1: Use a damp sponge to clean dirt and grime from trim. If needed, use the rough side of a sponge to ensure a clean starting surface.

STEP 2: Sand the surface. After the trim has been sanded, use a damp sponge to wipe away any dust.

SANDING TIP: If the trim is smooth, lightly sand using 120-grit sandpaper until all shine disappears from the trim. If the trim has a rough milling area start by sanding with coarse, 80-grit sandpaper. Then, move to less-coarse sandpaper such as 100 or 120-grit to smooth the surface.

STEP 3: Fill in holes, dents and cracks with a lightweight spackling compound. (Follow directions on the spackling container for best results.) When the spackle dries completely, lightly sand the spackled areas using 120-grit sandpaper to smooth out the surface. Use tack cloth to remove any sanding dust from the trim.

STEP 4: Dust off walls and ceiling around the trim to ensure painter's tape adheres well. Apply painter's tape to walls and ceilings surrounding the trim, being careful not to stick the tape to the trim itself. To prevent paint from bleeding through the tape, try to use one long piece of tape instead of multiple shorter pieces.

STEP 5: After you have applied the tape, press the tape's edges with a clean spackling or putty knife to ensure adhesion, as this helps prevent the paint from bleeding through the edges.

FLAT STOCK

INTERIOR DOORS

STAIR PARTS

TECHNICAL INFORMATION

NOTES

PART 2 • PAINT THE TRIM AND BOARDS

STEP 1: Apply primer to trim, covering any bare wood and spackled areas. Allow primer to dry for 24 hours. After the drying period, if bare wood or spackle is showing, apply another coat of primer to the trim.

STEP 2: After the primer dries, lightly sand the trim using 120-grit sandpaper to eliminate brush strokes or paint drips. Use a damp sponge or tack cloth to remove all sanding dust.

STEP 3: Apply paint to the trim using short, horizontal brush or spray-gun strokes. Repeat the motion until a few feet of trim (not the full length) are covered in paint.

STEP 4: Allow the paint to dry for 24 hours. After the drying period, for latex paint lightly sand the trim using 180-grit sandpaper to eliminate brush strokes or paint drips. Use a sponge or tack cloth to remove all sanding dust. Oil based paint does not require sanding between paint applications. Apply paint to the trim using short, horizontal brush or spray-gun strokes. Repeat the motion until a few feet of trim (not the full length) are covered in paint.

STEP 5: Before paint dries, carefully pull tape off of the wall and trim.

RETURNS

Material returns are subject to Western Pacific approval. Western Pacific will accept a return of a product, for credit, that has been purchased from Western Pacific inventory. Western Pacific will not accept a return of product, for credit, that has been modified or damaged by a person or party other than Western Pacific. Examples of such product are millwork items that have been cut in length, hardware not in its original box, etc. Furthermore, product ordered for a specific job, such as pre-hung doors, non-stock doors only, pre-finished millwork, etc., may not be returned for credit.

CANCELLATIONS & CHANGES

Once an order has been placed for custom items, pre-hung doors, or windows, the order may not be cancelled or otherwise changed.

WARRANTY

Western Pacific makes no representations or warranties, either expressed or implied, with respect to the building materials beyond those specifically made by the manufacturer. We can help coordinate warranty resolution for products, but it will be your responsibility to contact the manufacturer directly. Western Pacific is not responsible for any type of freight charges for warranty issues and is not responsible for warranty issues or discrepancies for products exported outside the USA.

DELIVERY

Western Pacific will make every effort to deliver all product in a timely manner. However, Western Pacific assumes no liability for theft, or delivery delays, beyond the reasonable control of Western Pacific.

PAYMENT

All charges are due and payable on the 10th of each month, except for cash accounts which are due prior to production. Any billing discrepancies must be raised within 10 days. Buyer acknowledges that any quotes or bids from Western Pacific are only for the materials listed and buyer assumes responsibility to ensure quantities are sufficient to complete the job.



April • 2021

LOCATIONS

Austin • Texas

15855 Long Vista Dr. • Ste 103
Austin, TX 78728
Phone: 512-989-1445

Houston • Texas

7607 Bluff Point Drive
Houston, TX 77086
Phone: 832-975-0070
Fax: 832-975-0071

Denver • Colorado

320 S Lipan Street
Denver, CO 80223
Phone: 303-454-8811
Fax: 303-394-3312

Seattle • Washington

1101 Industry Street
Everett, WA 98203
Phone: 425-366-8828
Fax: 425-742-5280

Bellevue • Washington Design Studio

13208 NE 20th Street • Suite 150
Bellevue, WA 98005
Phone: 425-250-8327
Fax: 425-558-5828

Portland • Oregon

2805 NW 31st Avenue
Portland, Oregon 97210
Phone: 503-223-8818
Fax: 503-224-9129

Medford • Oregon

502 Parsons Drive
Medford, OR 97501
Phone: 541-772-8818
Fax: 541-770-3736

HOURS

MONDAY - FRIDAY
7 AM - 4:00 PM

gowestpac.com