



*Service You Can Build On*

*Carpenters'  
Moulding  
Guide*

WASHINGTON

425 • 366 • 8828

[GoWestPac.com](http://GoWestPac.com)



For over 30 years, family-owned and locally operated Western Pacific has been supplying the building industry with quality products for new home construction.

As an environmentally and socially conscious Oregon company, we source the majority of our windows, doors and mouldings from regionally owned and operated manufacturers in the Pacific Northwest.

Our mission is to supply quality products on-time to meet evolving homebuilders' needs.

We thank you for your business and look forward to working with you on your home.

Fill-ins & End-of-Job Pick Ups

425 • 742 • 5195

Scheduling Department

425 • 610 • 2029

## RETURNS

Material returns are subject to Western Pacific approval. Western Pacific will accept a return of a product, for credit, that has been purchased from Western Pacific inventory.

Western Pacific will not accept a return of product, for credit, that has been modified or damaged by a person or party other than Western Pacific. Examples of such product are millwork items that have been cut in length, hardware not in its original box, etc.

Furthermore, product ordered for a specific job, such as pre-hung doors, non-stock doors only, pre-finished millwork, etc., may not be returned for credit.

## CANCELLATIONS & CHANGES

Once an order has been placed for custom items, pre-hung doors, or windows, the order may not be cancelled or otherwise changed.

## WARRANTY

Western Pacific makes no representations or warranties, either expressed or implied, with respect to the building materials beyond those specifically made by the manufacturer. We can help coordinate warranty resolution for products, but it will be your responsibility to contact the manufacturer directly. Western Pacific is not responsible for any type of freight charges for warranty issues and is not responsible for warranty issues or discrepancies for products exported outside the USA.

## DELIVERY

Western Pacific will make every effort to deliver all product in a timely manner. However, Western Pacific assumes no liability for theft, or delivery delays, beyond the reasonable control of Western Pacific.

## PAYMENT

All charges are due and payable on the 10th of each month, except for cash accounts which are due prior to production. Any disputes must be raised within 10 days. Buyer acknowledges that any quotes or bids from Western Pacific are only for the materials listed and buyer assumes responsibility to ensure quantities are sufficient to complete the job.



## LOCATIONS

### Seattle • Washington

1101 Industry Street  
Everett, WA 98203  
Phone: 425-366-8828  
Fax: 425-742-5280

### Bellevue • Washington Design Studio

13208 NE 20th Street • Suite 150  
Bellevue, WA 98005  
Phone: 425-250-8327  
Fax: 425-558-5828

### Portland • Oregon

2805 NW 31st Avenue  
Portland, Oregon 97210  
Phone: 503-224-9142  
Fax: 503-224-9129

### Medford • Oregon

502 Parsons Drive  
Medford, OR 97501  
Phone: 541-772-8818  
Fax: 541-770-3736

### Denver • Colorado

320 S Lipan Street  
Denver, CO 80223  
Phone: 303-454-8811  
Fax: 303-394-3312

### Houston • Texas

7607 Bluff Point Drive  
Houston, TX 77086  
Phone: 832-975-0070  
Fax: 832-975-0071

### Austin • Texas

15855 Long Vista Dr. • Ste 103  
Austin, TX 78728  
Phone: 512-989-1445  
Fax: 512-609-8114

## HOURS

**MONDAY - FRIDAY**  
**7 AM - 4:30 PM**



# ROUGH OPENINGS

## INTERIOR

	SINGLE DOORS	ASTRAGAL PAIRS	BALL-CATCH PAIRS
2'-0"	26"X83"	50-1/2"X83"	50"X83"
2'-4"	30"X83"	58-1/2"X83"	58"X83"
2'-6"	32"X83"	62-1/2"X83"	62"X83"
2'-8"	34"X83"	66-1/2"X83"	66"X83"
3'-0"	38"X83"	74-1/2"X83"	74"X83"

### BIFOLD DOORS

R.O. Height: 82"

DryWall Jamb Width : Door Width + 1-1/4"

All Wood Jamb Width : Door Width + 2"

### BIPASS DOORS

R.O. Height: 83"

DryWall Jamb Width : Door Width X 2

All Wood Jamb Width : (Door Width X 2) + 1"

### POCKET DOORS

#### WOOD FRAME

(Door Width X 2) + 2"

(Door Height) + 4-1/2"

Example: 2668 = 62" X 84-1/2"

#### JOHNSON FRAME

(Door Width X 2) + 1"

(Door Height) + 4-1/2"

Example: 2668 = 61" X 84-1/2"

### BARN DOORS

R.O. Width  $\leq$  Door Width

R.O.Height  $\leq$  Door Height +1"

## EXTERIOR

SINGLE DOORS	6/8	7/0	8/0
2' 6"	32" X 83"	32" X 87"	32" X 99"
2' 8"	34" X 83"	34" X 87"	34" X 99"
2' 10"	36" X 83"	36" X 87"	36" X 99"
3' 0"	38" X 83"	38" X 87"	38" X 99"

12" Transoms over 6'-8" Doors are normally 96-1/4" height

### SIDELITE UNITS

Widths

#### 1 SIDELITE • 1 DOOR

(Door Width) + (S/L Width) + 3-1/2"

#### 2 SIDELITES • 1 DOOR

(Door Width) + (S/L Width X 2) + 5"

#### 2 SIDELITES • 2 DOORS

(Door Width X 2) + (S/L Width X 2) + 6"

### PAIRS

Heights:

(Door Width X 2) + 3"

6'8" Height : 83"

7'0" Height : 87"

8'0" Height : 99"



# SERVICES



## JOB SITE TAKEOFF

Our experienced, professional team will walk your jobsite and do a detailed takeoff, including as needed: prehung doors, millwork, stairparts, locks & hardware, and windows.



## PREHUNG DOORS

Your dedicated WestPac team will machine and assemble our quality doors together with jambs, brickmould, weatherseals, and other components into a ready-to-install unit, with great care and quality in mind.



## CUSTOM DOORS

If you're aiming for unique interior design, or exclusive entry doors, we have experts on hand who will transform your creative vision into reality.



## CUSTOM MILLWORK

Whether it's beautiful arch surrounds and casing, custom run moulding patterns, or exotic wood species, we have you covered with WestPac's experienced custom millwork shop.



## HAND PULLED MOULDING PACKS

We take pride in our vast assortment of casing, base, crown, and closet material, and we'll handle with care as we package your items in the quantities and lengths you need.



## JOB SITE DELIVERY

We deliver, rain or shine, on time to your jobsite. We get your order right and deliver it to your site quickly, so you can meet your deadlines with no surprises.



## MOBILE APP

Maximize your efficiency by getting up-to-the-minute updates on your order status and delivery schedule by using our WestPac mobile app.

# BASIC MOULDING TERMINOLOGY

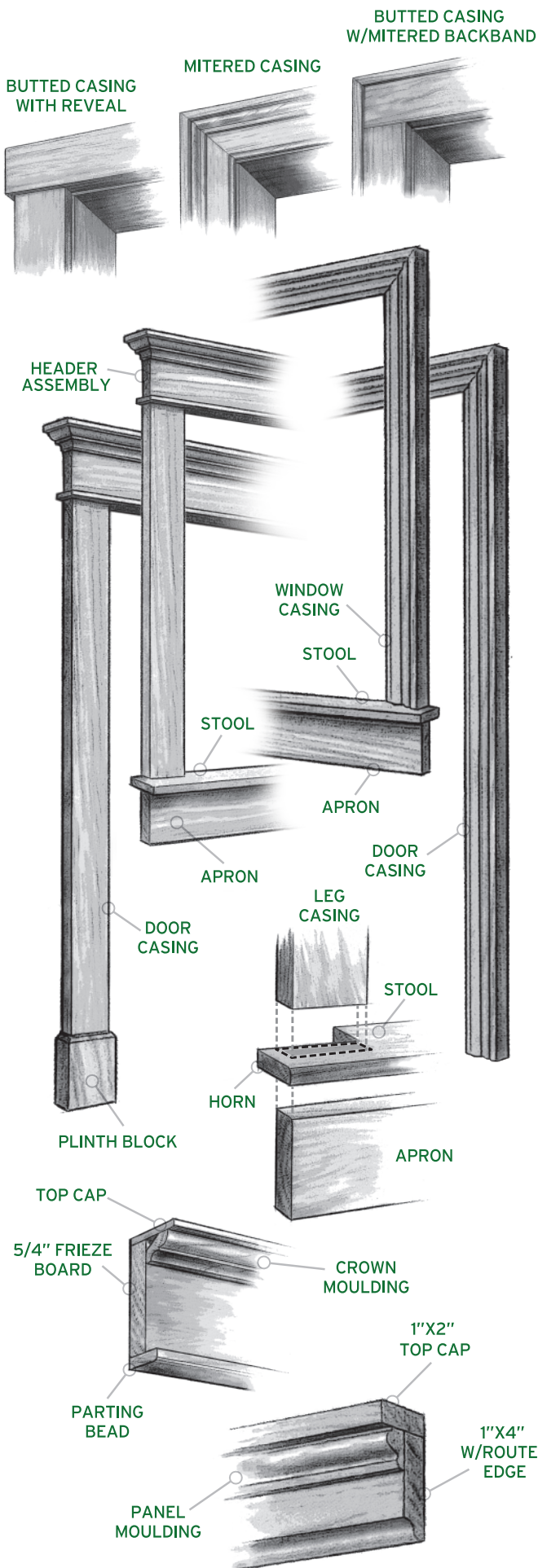

MOULDING

FLAT STOCK

INTERIOR DOORS

STAIR PARTS

HARDWARE

TECHNICAL INFORMATION

NOTES

# TRANSITIONAL

Style

M

MOULDING

FLAT STOCK

INTERIOR DOORS

STAIR PARTS

HARDWARE

TECHNICAL INFORMATION

NOTES

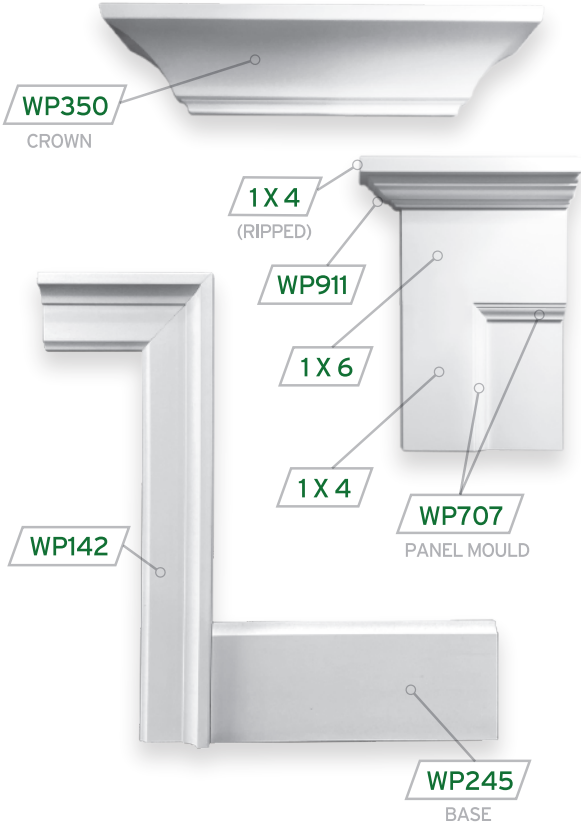

# CLASSIC

Style

A

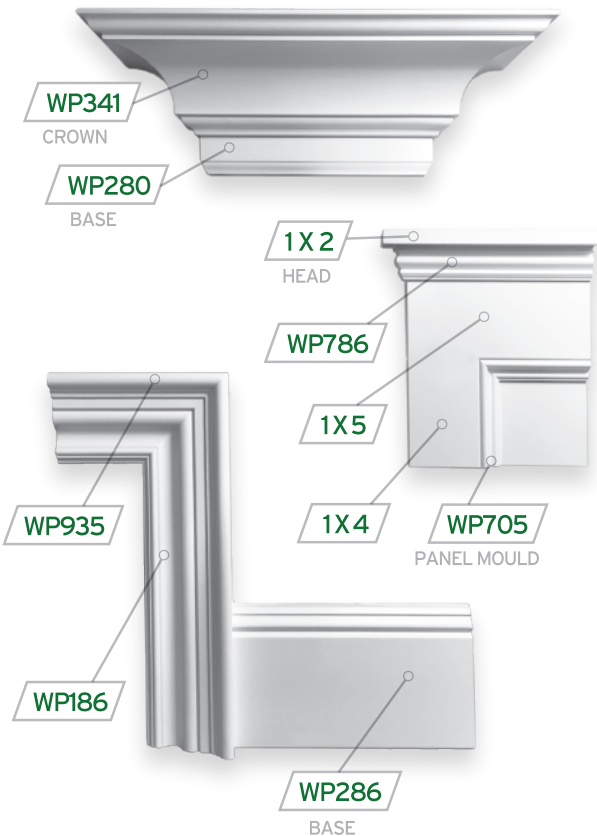

# CLASSIC Style

C

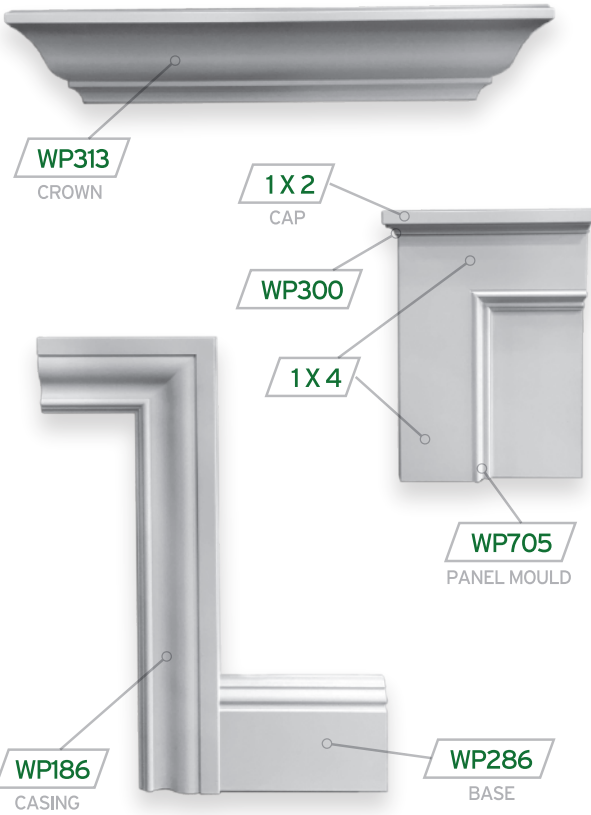

# CLASSIC Style

D



MOULDING

FLAT STOCK

INTERIOR DOORS

STAIR PARTS

HARDWARE

TECHNICAL INFORMATION

NOTES

# CRAFTSMAN

## Style

G

MOULDING

FLAT STOCK

INTERIOR DOORS

STAIR PARTS

HARDWARE

TECHNICAL INFORMATION

NOTES

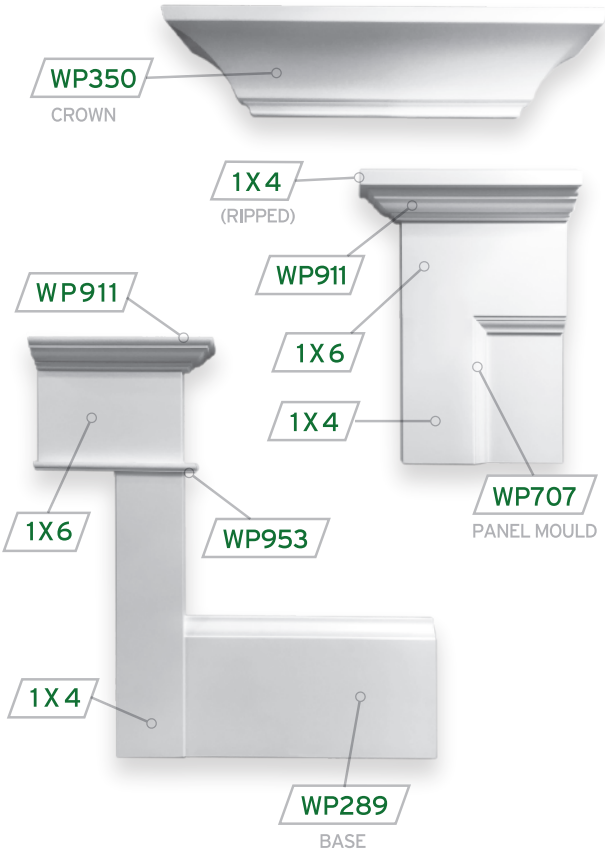

# CRAFTSMAN

## Style

I

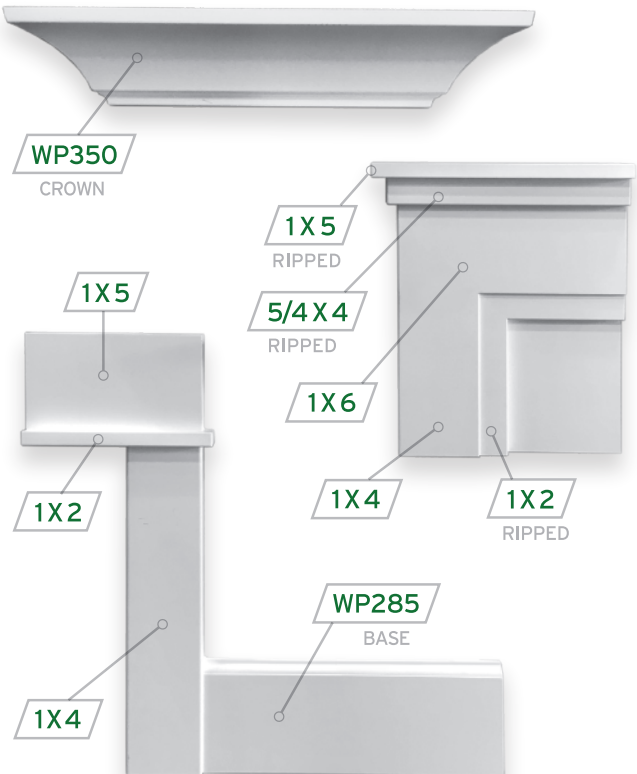

# CRAFTSMAN

## Style

### E

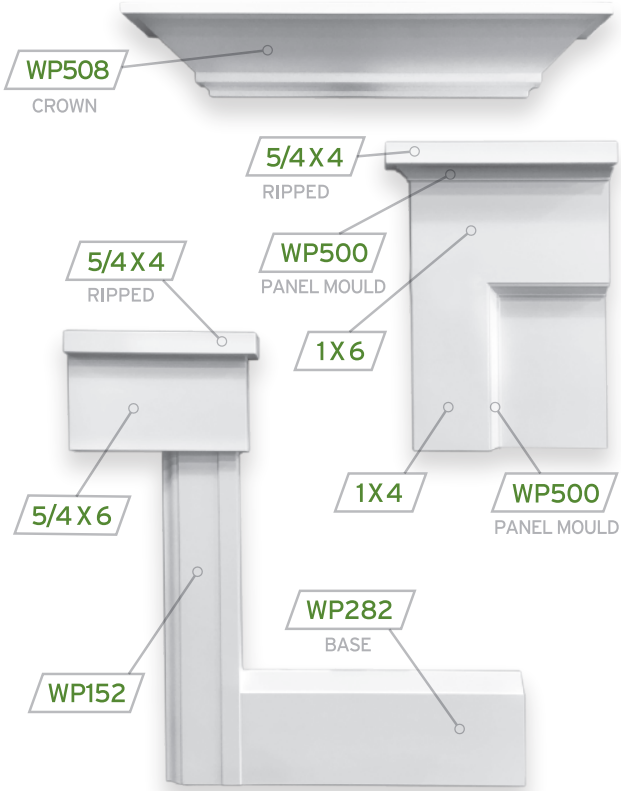

MOULDING

FLAT STOCK

INTERIOR DOORS

STAIR PARTS

# CRAFTSMAN

## Style

### F

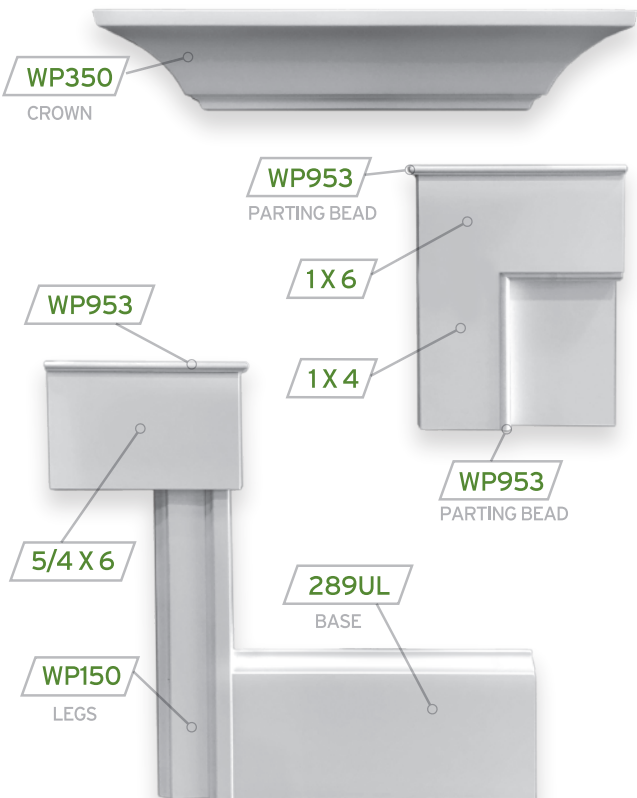

HARDWARE

TECHNICAL INFORMATION

NOTES



Moulding dimensions subject to change without notice, contact your local WestPac office for correct dimensions



HEM  
SO

**WP105\***

CASING  
1/2" X 1-1/2"

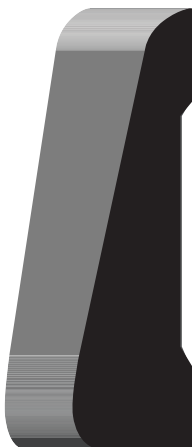

HEM  
CO

**WP130\***

CASING  
9/16" X 2-1/4"

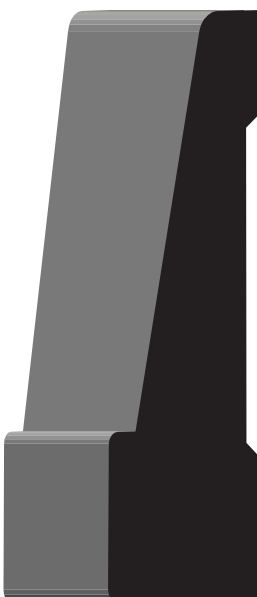

PMDF

**WP185**

CASING  
11/16" X 3-1/4"

MOULDING

FLAT STOCK

INTERIOR DOORS

STAIR PARTS

HARDWARE

TECHNICAL INFORMATION

NOTES

Moulding dimensions subject to change without notice, contact your local WestPac office for correct dimensions



**WP184\***

CASING  
1" X 3-1/2"



**WP186\***

CASING  
11/16" X 3-1/2"

\*SPECIAL ORDER  
PROFILES ARE NOT NECESSARILY ACTUAL SIZE

Moulding dimensions subject to change without notice, contact your local WestPac office for correct dimensions



**WP142**

CASING  
1" X 1-3/4"

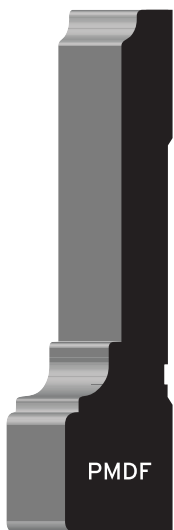

**WP144**

CASING  
1" X 4-1/4"



**WP143**

CASING  
1 1/16" X 3-1/4"



**WP156**

CASING  
9/16" X 2-1/4"

MOULDING

FLAT STOCK

INTERIOR DOORS

STAIR PARTS

HARDWARE

TECHNICAL INFORMATION

NOTES

Moulding dimensions subject to change without notice, contact your local WestPac office for correct dimensions



**WP145\***

CASING  
5/8" X 2-1/4"

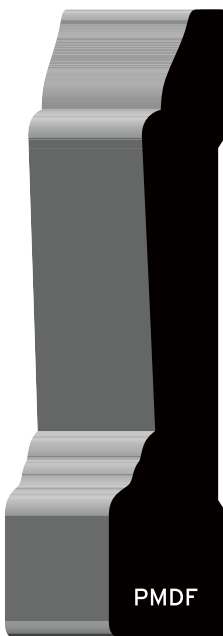

**WP150**

CASING  
9/16" X 3-1/4"



**WP152**

CASING  
9/16" X 3-1/2"

**\*SPECIAL ORDER**  
PROFILES ARE NOT NECESSARILY ACTUAL SIZE

Moulding dimensions subject to change without notice, contact your local WestPac office for correct dimensions



MDF

**WP114**

CASING  
11/16" X 3-1/4"



FIN  
HEM  
PMDF

**WP175**

7/16" X 2-1/4"



HEM

**WP100**

CASING  
7/16" X 1-1/2"

Moulding dimensions subject to change without notice, contact your local WestPac office for correct dimensions



**WP287**

9/16" X 7"



**WP286**

9/16" X 5-1/4"

Moulding dimensions subject to change without notice, contact your local WestPac office for correct dimensions



**WP270\***

BASE  
1/2" X 2-1/4"



**WP279**

BASE  
3/8" X 3-1/4"



**WP282**

BASE  
9/16" X 5-1/4"



**WP285**

BASE  
1/2" X 5-1/4"



**WP280**

BASE  
1/2" X 3-1/4"



Moulding dimensions subject to change without notice, contact your local WestPac office for correct dimensions



WP297\*

BASE  
9/16" X 7-1/4"



WP295\*

BASE  
9/16" X 5-1/4"

Moulding dimensions subject to change without notice, contact your local WestPac office for correct dimensions

P MDF



**WP313**

CROWN  
9/16" X 4-1/4"

P=2-1/2"

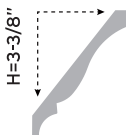

P MDF



**WP512**

CROWN  
5-1/4" X 9/16"

P=3-1/4"

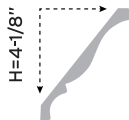

P MDF



**WP343\***

CROWN  
1" X 6-15/16"

P=4-3/4"

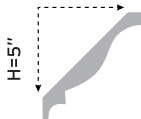

HEM  
P MDF



**WP351**

CROWN  
HEM • 9/16" X 3-1/4"  
UL • 9/16" X 3-5/8"

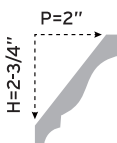

HEM  
P MDF



**WP354\***

CROWN  
9/16" X 2-1/4"

P=1-5/8"

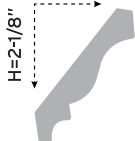

HEM



**WP368\***

CROWN  
9/16" X 1-5/8"

P=1"

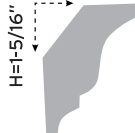

Moulding dimensions subject to change without notice, contact your local WestPac office for correct dimensions



**WP353\***

CROWN  
9/16" X 3-1/2"

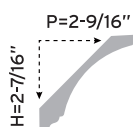

**WP350\***

CROWN  
5/8" X 5-3/16"

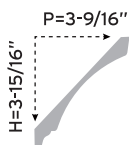

**WP341**

CROWN  
1-3/16" X 6-5/16"

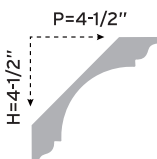

**WP340**

CROWN  
11/16" X 4-1/4"

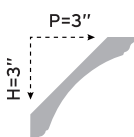

\*SPECIAL ORDER

PROFILES ARE NOT NECESSARILY ACTUAL SIZE

Moulding dimensions subject to change without notice, contact your local WestPac office for correct dimensions



**WP308\***

CROWN  
3/4" X 3-1/4"

P=2-1/8"

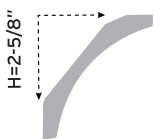

**WP309**

CROWN  
3/4" X 5-1/4"

P=3-3/8"

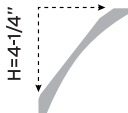

**WP310**

CROWN  
1" X 7"

P=4-3/4"

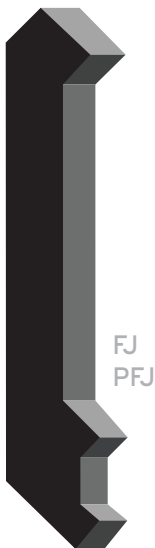
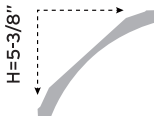

**WP508\***

CROWN  
11/16" X 4-5/8"

P=3-1/8"

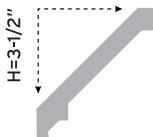

**CTC1W3**

CROWN  
1" X 4-1/4"

P=3-1/8"



Moulding dimensions subject to change without notice, contact your local WestPac office for correct dimensions



**WP3248\***

Chair Rail  
1-3/16" X 2-3/16"



**WP3244\***

Chair Rail  
5/8" X 1-1/4"

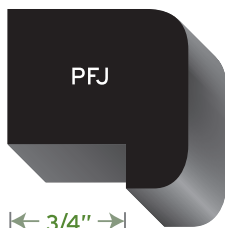

**WP1021\***

BACKBAND  
1-1/16" X 1-1/16"

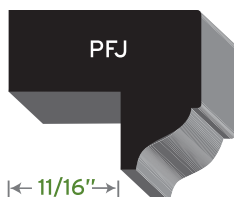

**WP922**

BACKBAND  
1-1/8" X 1-5/16"



**WP383**

BACKBAND  
1-3/8" X 2-7/16"



**WP504\***

LINTEL  
1-1/2" X 2-3/8"

Moulding dimensions subject to change without notice, contact your local WestPac office for correct dimensions



**PFJ16TG**  
T & G BEADED  
REVERSIBLE  
9/16 X 5-3/8"



**WP126**  
SHIPLAP  
1/2" X 5-5/16"



**WP128**  
SHIPLAP  
1/2" X 7-5/16"



**WP1008\***  
CHAIR RAIL  
11/16" X 3"



**WP1004\***  
CHAIR RAIL  
5/8" X 2-7/16"

Moulding dimensions subject to change without notice, contact your local WestPac office for correct dimensions



PFJ

**WP705\***

PANEL MOULD  
3/4" X 1-1/8"



HEM

**WP701\***

PANEL MOULD  
5/8" X 1-3/8"



PFJ

**WP772\***

PANEL MOULD  
1/2" X 1"



HEM  
FLEX  
FJ

**WP706\***

PANEL MOULD  
3/4" X 2"



HEM  
FJ

**WP704\***

PANEL MOULD  
5/8" X 5/8"



HEM

**WP707\***

PANEL MOULD  
5/8" X 3/4"



HEM

**WP430**

SCREEN  
1/4" X 3/4"



MOULDING

FLAT STOCK

INTERIOR DOORS

STAIR PARTS

HARDWARE

TECHNICAL INFORMATION

NOTES

Moulding dimensions subject to change without notice, contact your local WestPac office for correct dimensions

HEM

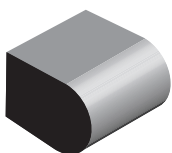

**WP3428\***

PARTING BEAD  
7/16" X 3/4"

HEM  
PMDF

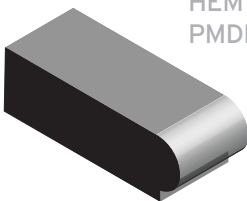

**WP953**

PARTING BEAD  
7/16" X 1-3/8"

HEM

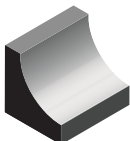

**WP3260**

COVE  
1/2" X 1/2"

HEM  
OAK

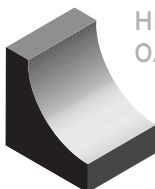

**WP3264\***

COVE  
3/4" X 3/4"

HEM

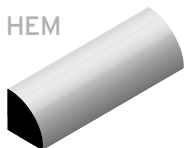

**WP320**

QUARTER ROUND  
1/4" X 1/4"

HEM

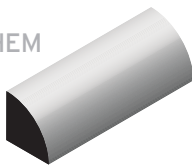

**WP321\***

QUARTER ROUND  
3/8" X 3/8"

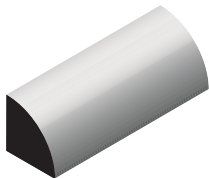

**WP322\***

QUARTER ROUND  
1/2" X 1/2"

HEM

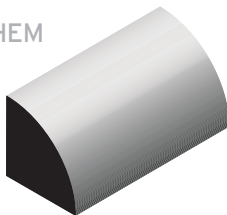

**WP324\***

QUARTER ROUND  
11/16" X 11/16"

ALD  
PFJ  
HEM

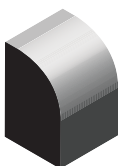

**WP451**

BASE SHOE  
7/16" X 3/4"

PWMDF

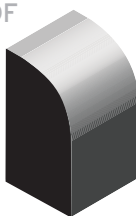

**WP3288**

BASE SHOE  
1/2" X 3/4"

Moulding dimensions subject to change without notice, contact your local WestPac office for correct dimensions



**WP5020\***

ARCHITRAVE  
1-3/16" X 5-1/4"



PMDF

**WP5010\***

ARCHITRAVE  
1-3/16" X 4-3/16"



**WP5000**

ARCHITRAVE  
1-3/16" X 3-3/4"

PMDF

# FLATSTOCK

## SPECIES & SIZES AVAILABLE

	P MDF	P FJ	H E M	F I R	P O P	K A	O A K	C H E R R Y
1/2" X 3"	S	X	A	A	X	X	X	X
1/2" X 4"	S	S	S	A	A	A	A	X
1/2" X 5"	S	X	S	X	X	X	X	X
1/2" X 6"	S	S	S	A	A	A	A	X
1/2" X 7"	X	X	S	X	X	X	X	X
1/2" X 8"	S	X	S	X	X	X	X	X
1" X 2"	S	S	S	A	A	S	A	A
1" X 3"	S	S	S	A	A	S	A	A
1" X 4"	S	S	S	A	A	S	A	A
1" X 5"	S	S	S	A	A	S	A	A
1" X 6"	S	S	S	A	A	S	A	A
1" X 7"	S	S	S	X	X	X	X	X
1" X 8"	S	S	S	A	A	S	A	A
1" X 10"	S	S	S	A	A	S	A	X
1" X 12"	S	S	S	A	A	S	A	X
5/4" X 4"	S	S	S	A	A	A	A	X
5/4" X 6"	S	S	S	A	A	S	A	X
5/4" X 8"	S	X	S	A	A	A	A	X

S STOCKED      A AVAILABLE \*      X NOT AVAILABLE

\*Typically available - but requires confirmation.

## LENGTHS AVAILABLE

MDF	16' LENGTHS
FINGER JOINT	16' LENGTHS
HEMLOCK	RANDOM LENGTHS
FIR	RANDOM LENGTHS
POPLAR	RANDOM LENGTHS
KNOTTY ALDER	SHORT RANDOM LENGTHS
OAK	RANDOM LENGTHS
CHERRY	RANDOM LENGTHS

# WESTPAC CASCADE DOORS

SHAKER/SQUARE STICKING • FLAT PANEL  
1-3/8" • STILE & RAIL • 6/8 & 8/0  
(1-3/4" AVAILABLE IN 2/8 AND 3/0 WIDTHS)

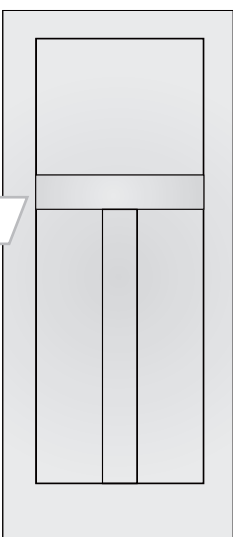
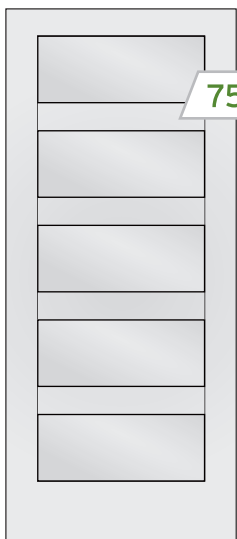
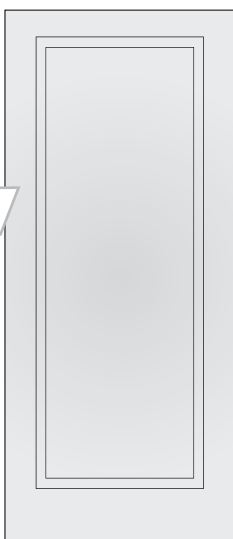
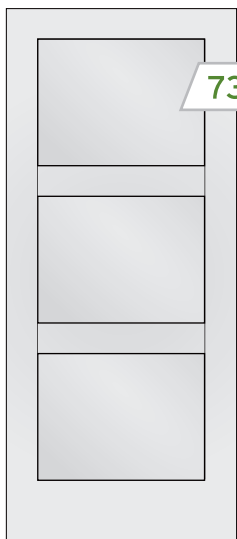
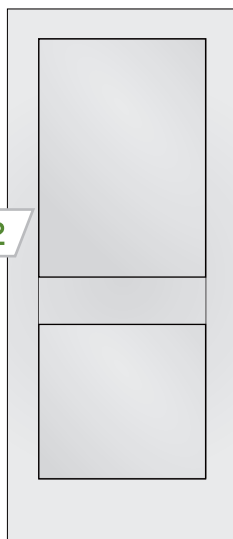
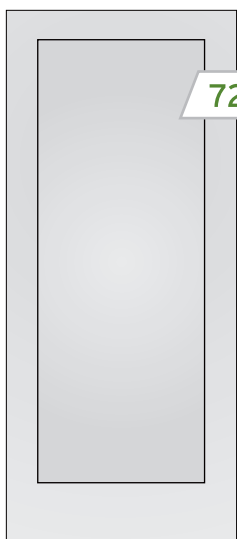

MOULDING

FLAT STOCK

INTERIOR DOORS

STAIR PARTS

HARDWARE

TECHNICAL INFORMATION

NOTES

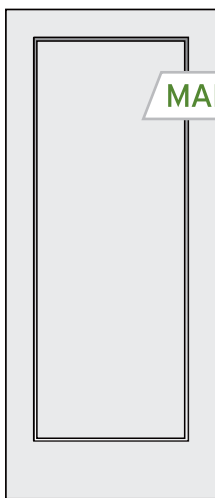

**MADISON**

FLAT PANEL  
SMOOTH  
PASSAGE/BIFOLD  
6/8 • 8/0



**CRAFTSMAN**

FLAT PANEL  
SMOOTH  
PASSAGE/BIFOLD  
6/8 ONLY

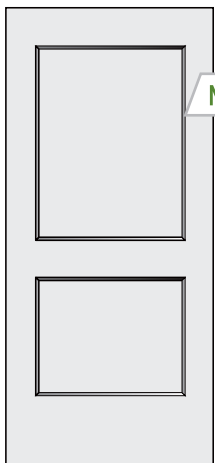

**MONROE**

FLAT PANEL  
SMOOTH  
PASSAGE/BIFOLD  
6/8 ONLY

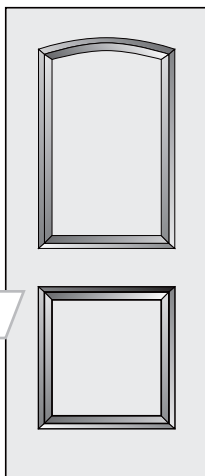

**CAIMAN**

SMOOTH  
PASSAGE/BIFOLD  
6/8 • 8/0

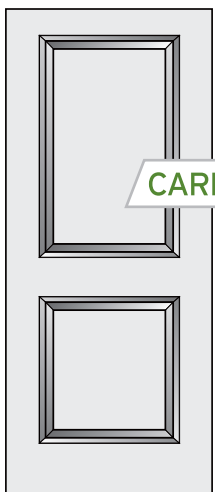

**CARRARA**

SMOOTH  
PASSAGE/BIFOLD  
6/8 • 8/0

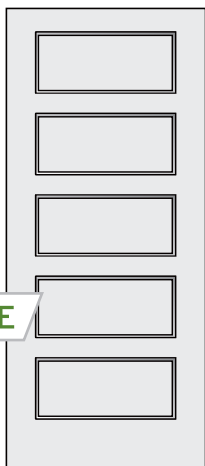

**CONMORE**

FLAT PANEL  
SMOOTH  
PASSAGE/BIFOLD  
6/8 ONLY

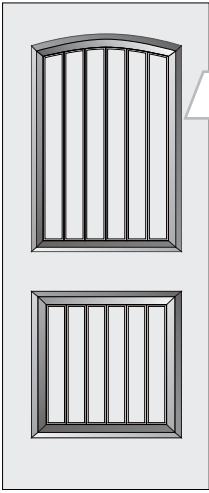

**LOPEZ**

SMOOTH  
PASSAGE/BIFOLD  
6/8 • 8/0

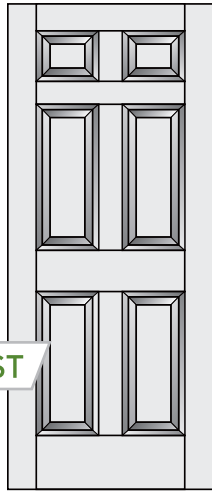

**COLONIST**

SMOOTH or  
TEXTURED  
PASSAGE/BIFOLD  
6/8 • 8/0

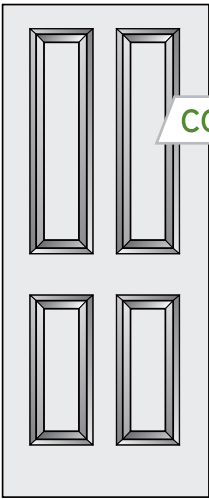

**COVENTRY**

SMOOTH  
PASSAGE/BIFOLD  
6/8 • 8/0

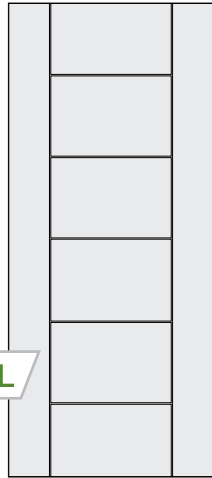

**HAMEL**

SMOOTH  
PASSAGE/BIFOLD  
FLUSH W/KERF LINES  
6/8 • 7/0

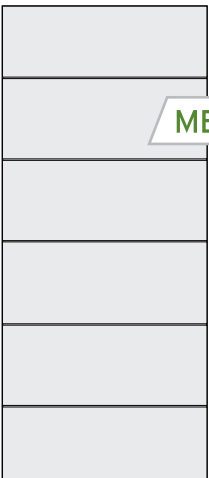

**MELROSE**

SMOOTH  
PASSAGE/BIFOLD  
FLUSH W/KERF LINES  
6/8 • 7/0

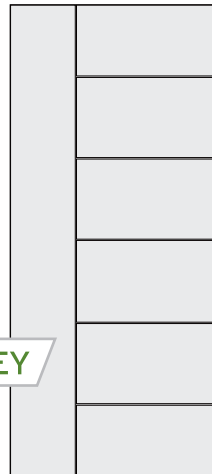

**BERKLEY**

SMOOTH  
PASSAGE/BIFOLD  
FLUSH W/KERF LINES  
6/8 • 7/0

# HANDRAILS

MOULDING

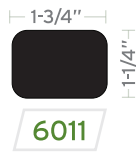
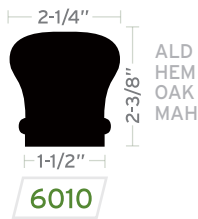

FLAT STOCK

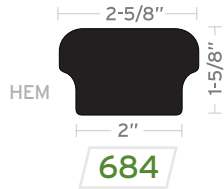

Handrails can be plowed upon request

INTERIOR DOORS

STAIR PARTS

HARDWARE

TECHNICAL INFORMATION

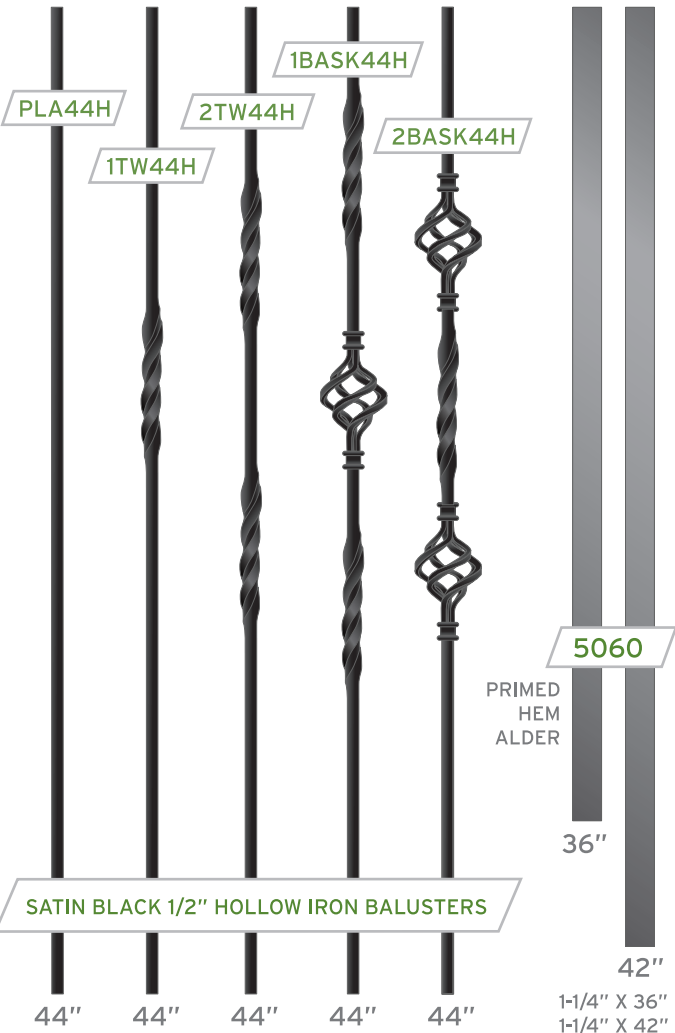

NOTES





# FITTINGS

MOULDING

FLAT STOCK

INTERIOR DOORS

STAIR PARTS

HARDWARE

TECHNICAL INFORMATION

NOTES

CHAMFERED  
TOP BLANK  
NEWEL  
3-1/2" X 56"

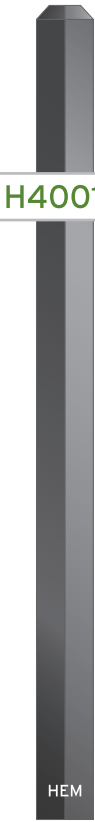

H4001C

HEM



C3002

STANDARD DUTY  
HANDRAIL BRACKET



S3027

HEAVY DUTY  
HANDRAIL BRACKET

6000F

FILLET  
HEM

1-1/4"

25/64"



6042

WALL RAIL  
HEM

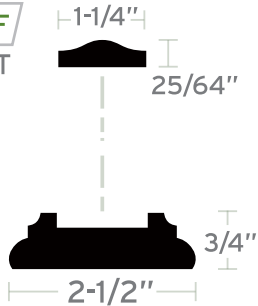

6045

SHOE RAIL  
HEM

# HARDWARE

## SLIDING DOOR HARDWARE SETS

MOULDING

FLAT STOCK

INTERIOR DOORS

STAIR PARTS

HARDWARE

TECHNICAL INFORMATION

NOTES



**GBT** BLACK OR SILVER



**SPRING DOOR STOP**



**FLOOR STOP**



**BYPASS CUPS**



**HINGE DOOR STOP**



**BF KNOBS**



**PEEP SIGHT**



**CLOSET ROD**

1-5/16"

# MISCELLANEOUS HARDWARE

24" TOWEL BAR



18" TOWEL BAR



HAND TOWEL BAR



BATH TISSUE BAR



ROBE HOOK



5" BRUSHED NICKEL HOUSE NUMBERS



5" BLACK HOUSE NUMBERS



POCKET DOOR  
PASSAGE



POCKET DOOR  
PRIVACY

MOULDING

FLAT STOCK

INTERIOR DOORS

STAIR PARTS

HARDWARE

TECHNICAL INFORMATION

NOTES

# RESIDENTIAL HARDWARE

## **Kwikset**

MOULDING



FLAT STOCK



INTERIOR DOORS

**CHELSEA**

**HAWTHORNE**

**TAVARIS**

STAIR PARTS

HARDWARE



**HANCOCK**



**780**

TECHNICAL INFORMATION



**TUSTIN**

LEVER

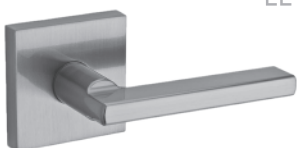

**HALIFAX**

LEVER



**HALIFAX**

DEADBOLT

NOTES

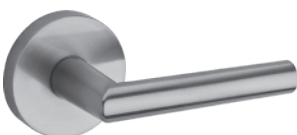

**MILAN**

LEVER



**MILAN**

DEADBOLT

# RESIDENTIAL HARDWARE

**SCHLAGE**



**ADDISON**  
HANDLESET

**CENTURY**  
HANDLESET

**PLYMOUTH**  
HANDLESET



**ACCENT**  
HANDSET



**SOLSTICE**  
LEVER



**LATITUDE**  
LEVER



**SEVILLE**  
LEVEL



**TORINO**  
LEVER



**STRATUS**  
KNOB



**CORONA**  
KNOB

MOULDING

FLAT STOCK

INTERIOR DOORS

STAIR PARTS

HARDWARE

TECHNICAL INFORMATION

NOTES

We also offer...

**EMTEK**  
**ASSA ABLOY**



**BALDWIN**

# FINISH LUMBER DESCRIPTIONS

3/4" thick with four square edges, and available in random lengths.

Custom Milling Available in all species:

- Sanding
- Ripping to Custom Width
- Planing to Custom Thickness

## RED OAK

Sapwood is white to light brown and the heartwood is a pink or reddish brown. Similar in appearance to White Oak, but with smaller grain rays. Red Oak is mostly straight-grained, with a coarse texture.

## WHITE OAK

The sapwood is light-colored and the heartwood is light to dark brown. White Oak is mostly straight-grained with a medium to coarse texture, and with longer grain rays than red oak.

## EASTERN HARD MAPLE

Creamy white in color with a fine, uniform texture and generally mixed grain.

## AMERICAN CHERRY

Rich red to reddish brown. Will darken with age and on exposure to light. May contain some creamy white sapwood. Fine uniform, straight grain, satiny, smooth texture.

## CLEAR ALDER

Light brown with a yellow or reddish tinge. Fairly straight-grained with a uniform texture. Occasional pin knots may be present.

## KNOTTY ALDER

Light brown with a yellow or reddish tinge. Fairly straight-grained with a uniform texture. Multiple large open and tight knots will be present.

## CVG FIR

Even, straight, vertical grain that stains out beautifully. Reddish in color. Also good for outdoors when painted.

## CVG HEMLOCK

Our most popular stain grade softwood. A close relative of Fir but more yellowish in color. Fine uniform texture and vertical grain pattern, that easily obtains a rich finish. Also good for paint grade.

## EASTERN POPLAR

Solid paint grade hardwood. Smooth and even surface that paints out beautifully. Our high quality Eastern Poplar is lighter in color, more dense, and less fuzzy when machining than Western varieties.

## WALNUT

Light to dark chocolate brown in color, with straight grain from the trunk and more waved grain near the roots. Walnut is hard and durable with excellent shaping qualities, making it one of the most popular and versatile woodworking species. It takes finish very well.

MOULDING

FLAT STOCK

INTERIOR DOORS

STAIR PARTS

HARDWARE

TECHNICAL INFORMATION

NOTES

# PAINTING INSTRUCTIONS

## RECOMMENDED PROCEDURE TO PAINT WOOD AND MDF MOULDINGS AND BOARDS

### PART 1 • PREPARE THE TRIM

**STEP 1:** Use a damp sponge to clean dirt and grime from trim. If needed, use the rough side of a sponge to ensure a clean starting surface.

**STEP 2:** Sand the surface. After the trim has been sanded, use a damp sponge to wipe away any dust.

**SANDING TIP:** If the trim is smooth, lightly sand using 120-grit sandpaper until all shine disappears from the trim. If the trim has a rough milling area start by sanding with coarse, 80-grit sandpaper. Then, move to less-coarse sandpaper such as 100 or 120 grit to smooth the surface.

**STEP 3:** Fill in holes, dents and cracks with a lightweight spackling compound. (Follow directions on the spackling container for best results.) When the spackle dries completely, lightly sand the spackled areas using 120 grit sandpaper to smooth out the surface. Use tack cloth to remove any sanding dust from the trim.

**STEP 4:** Dust off walls and ceiling around the trim to ensure painter's tape adheres well. Apply painter's tape to walls and ceilings surrounding the trim, being careful not to stick the tape to the trim itself. To prevent paint from bleeding through the tape, try to use one long piece of tape instead of multiple shorter pieces.

**STEP 5:** After you have applied the tape, press the tape's edges with a clean spackling or putty knife to ensure adhesion, as this helps prevent the paint from bleeding through the edges.

### PART 2 • PAINT THE TRIM AND BOARDS

**STEP 1:** Apply primer to trim, covering any bare wood and spackled areas. Allow primer to dry for 24 hours. After the drying period, if bare wood or spackle is showing, apply another coat of primer to the trim.

**STEP 2:** After the primer dries, lightly sand the trim using 120-grit sandpaper to eliminate brush strokes or paint drips. Use a damp sponge or tack cloth to remove all sanding dust.

**STEP 3:** Apply paint to the trim using short, horizontal brush or spray gun strokes. Repeat the motion until a few feet of trim (not the full length) are covered in paint.

**STEP 5:** Allow the paint to dry for 24 hours. After the drying period for latex paint, lightly sand the trim using 180 grit sandpaper to eliminate brush strokes or paint drips. Use a sponge or tack cloth to remove all sanding dust. Oil-based paint does not require sanding between paint applications. Apply paint to the trim using short, horizontal brush or spray-gun strokes. Repeat the motion until a few feet of trim (not the full length) are covered in paint.

**STEP 6:** Before the paint dries, carefully pull the tape off of the wall and trim.

MOULDING

FLAT STOCK

INTERIOR DOORS

STAIR PARTS

HARDWARE

TECHNICAL INFORMATION

NOTES

# STAINING INSTRUCTIONS

## RECOMMENDED WOOD STAINING PROCEDURE

### WOOD PREPARATION

Wood must be dry and cleaned of dirt, grease, wax, polish, and marks. See STEP 1 for details.

(For exterior wood doors, Western Pacific recommends Epifanes Wood Finish Matte top coat for the best results and long lasting finish. (Available at Marine Supply. Epifanes.com)

### THE "FINGERNAIL TEST"

Determine if you have a soft wood or a hard wood.

We consider Fir, Hemlock and Alder to be softwoods and Oak, Cherry and Maple are typically hardwoods. If your fingernail dents the surface when you scratch it, you have a soft wood.

Since soft woods tend to absorb stain unevenly and become blotchy easily, pre-treat the wood using pre-stain wood conditioner before staining. This critical extra step will help you control stain color penetration and prevent blotchiness.

### CHOOSING A COLOR

Your finished color is determined by many factors, from the color of the stain selected to how long the stain is left on. But remember: Different species of wood absorb stain differently. Test the color on an inconspicuous area or sample board before you start staining most visible parts of your project.

Always stop your staining process if you are not achieving your desired finish and ask a painting professional for additional advice.

To assure the highest quality results when applying interior wood stain, follow these steps.

**STEP 1:** Start with a medium grade of sandpaper (e.g., #120) and gradually work your way to a finer grade (e.g., #220). Sand in the direction of the grain for a smooth, uniform finish, and remove all sanding dust, using a vacuum, dry paint brush or tack cloth, before finishing.

**STEP 2:** Mix the stain thoroughly before you begin and frequently while you're staining. This helps keep the color consistent throughout the project. Ingredients in stains and finishes can settle over time. Stir until all settlement is evenly dispersed. Shaking will only add unwanted bubbles to the product.

**STEP 3:** Before proceeding, apply the stain on a discreet area of wood to test the color.

#### **TIP:** ●●●

Apply stain only at the proper temperature. For most stains, 70°F is the optimum, with the safety range from 50° to 90°F. Stains do vary, so check the label first. Avoid high humidity when applying stain. All finishes, including stains and paint, have trouble drying in humid conditions.

**STEP 4:** Apply stain by brushing or wiping it in the direction of the grain, using smooth and even strokes. Wipe off any excess.

#### **TIP:** ●●●

Avoid unattractive lap marks by applying stain from an unpainted area back into the last wet stain. In other words, don't let a section of stain dry before you blend it in with stain from an adjoining section.

**STEP 5:** Let dry completely (usually 24 hours). Apply a second coat of stain to achieve a darker look.

**STEP 6:** After the wood is dry, brush or spray on a uniform coat of your top coat product. After the top coat dries, lightly sand the trim using 220-grit sandpaper to eliminate brush strokes or paint drips. Use a damp sponge or tack cloth to remove all sanding dust.

MOULDING

FLAT STOCK

INTERIOR DOORS

STAIR PARTS

HARDWARE

TECHNICAL INFORMATION

NOTES